

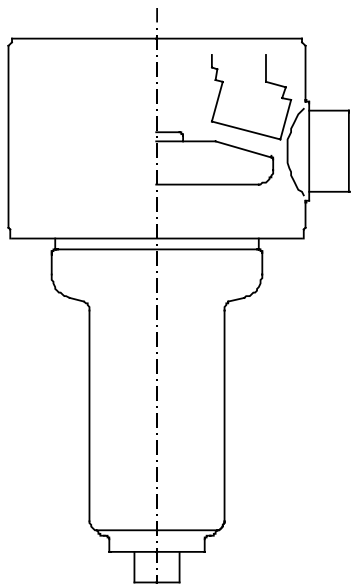

Documentazione Tubo a raggi X
Tube Documentation
Documentation du Tube

XM15 T 0.1/0.3



Nr. di matricola
Tube No.
Nr de série



Questa documentazione deve essere fornita all'utilizzatore del complesso tubo-guaina
The contents of this documentation must be transmitted to the user of the tube-assembly
Le contenu de cette documentation doit être transmis à l'utilisateur de la gaine équipée

Documentazione N° Documentation N° N° de Documentation	Revisione Edition Version	Data di edizione Date of release Date de l'édition	Testo originale Original text Texte original
XM5TS13	A	08.06.2010	italiano / italian / italien

I.A.E Spa

via Fabio Filzi, 53 - 20032 CORMANO (MI) Italy
Tel: ++39-0266303255 Fax: ++39-026152544
<http://www.iae.it> e-mail: iaexray@iae.it





Sommario - Table of contents - Table des matières

Sommario - Table of contents - Table des matières	2
Caratteristiche - Specifications - Spécifications	3
Dimensioni - Dimension - Dimensions	4
Curva di raffreddamento dell'anodo Anode cooling curve Courbe de refroidissement de l'anode	5
Curve di riscaldamento dell'anodo Anode heating curves Courbes d'échauffement de l'anode.....	5
CURVE DI CARICO SINGOLO - SINGLE LOAD RATING - ABAQUE DE CHARGE UNIQUE <input type="checkbox"/> 0.1 - 1 ~ - 3000 min ⁻¹	6
CURVE DI CARICO SINGOLO - SINGLE LOAD RATING - ABAQUE DE CHARGE UNIQUE <input type="checkbox"/> 0.3 - 1 ~ - 3000 min ⁻¹	6
CURVE DI CARICO SINGOLO - SINGLE LOAD RATING - ABAQUE DE CHARGE UNIQUE <input type="checkbox"/> 0.1 - 3 ~ - 3000 min ⁻¹	7
CURVE DI CARICO SINGOLO - SINGLE LOAD RATING - ABAQUE DE CHARGE UNIQUE <input type="checkbox"/> 0.3 - 3 ~ - 3000 min ⁻¹	7
CURVE DI CARICO SINGOLO - SINGLE LOAD RATING - ABAQUE DE CHARGE UNIQUE <input type="checkbox"/> 0.1 - 1 ~ - 10000 min ⁻¹	8
CURVE DI CARICO SINGOLO - SINGLE LOAD RATING - ABAQUE DE CHARGE UNIQUE <input type="checkbox"/> 0.3 - 1 ~ - 10000 min ⁻¹	8
CURVE DI CARICO SINGOLO - SINGLE LOAD RATING - ABAQUE DE CHARGE UNIQUE <input type="checkbox"/> 0.1 - 3 ~ - 10000 min ⁻¹	9
CURVE DI CARICO SINGOLO - SINGLE LOAD RATING - ABAQUE DE CHARGE UNIQUE <input type="checkbox"/> 0.3 - 3 ~ - 10000 min ⁻¹	9
Caratteristica di emissione del catodo Cathode emission characteristic Caractéristique d'émission de la cathode <input type="checkbox"/> 0.1 - 3 ~ - (± 0.2 A)10	
Caratteristica di emissione del catodo Cathode emission characteristic Caractéristique d'émission de la cathode <input type="checkbox"/> 0.3 - 3 ~ - (± 0.2 A)10	

Dichiarazione di conformità

Questo prodotto soddisfa i requisiti essenziali della direttiva 93/42/CEE
in accordo alle norme EN 60613 (IEC 613) e EN 60336 (IEC 336)

Declaration of conformity

This tube fulfils the essential requirements of the directive 93/42/EEC
according to standard EN 60613 (IEC 613) and EN 60336 (IEC 336).

Confirmation de conformité

Ce tube remplit les exigences essentielles de la directive 93/42/CEE en
accord avec les normes EN 60613 (IEC 613) et EN 60336 (IEC 336).



Caratteristiche - Specifications - Spécifications

Macchie focali e condizioni di misura Focal spots and measure conditions Foyers et conditions de mesure	<input type="checkbox"/> 0.1 25 kV 20 mA <input type="checkbox"/> 0.3 25 kV 100 mA	(IEC 336, EN 60336)
Massima corrente di emissione Max emission current Max courant d'émission	<input type="checkbox"/> 0.1 35 mA 25 kV <input type="checkbox"/> 0.3 140 mA 25 kV	
Angolo tra asse di riferimento e piano della pista focale Angle_between axis reference and focal spot plane Angle entre axe de référence et surface de la piste focale	10 °	
Velocità di rotazione dell'anodo Anode speed Vitesse de l'anode	3000 min ⁻¹ 10000 min ⁻¹	
Potenza anodica nominale Nominal anode input power Puissance anodique nominale	<input type="checkbox"/> 2 kW 4 kW <input type="checkbox"/> 8 kW 16 kW	(IEC 613, EN 60613)
Diametro anodico Anode diameter Diamètre de l'anode	80 mm	
Materiale anodico Anode material Matériau de l'anode	RT-TZM	
Angolo anodico Anode angle Pente de l'anode	15 °	
Campo di radiazione con cuffia inclinata di 7.5° Radiation field with housing tilted at 7.5° Champ de rayonnement avec la gaine inclinée à 7.5°	18 cm a 50 cm	
Filtrazione inerente Inherent filtration Filtration inhérente	0.5 mm Be	
Capacità termica anodica Maximum anode heat content Chaleur maximale accumulée dans l'anode	225 kJ 300 kHU	
Dissipazione termica continua massima Maximum continuous heat dissipation Dissipation thermique continue maximale	715 W	
Alta tensione nominale Nominal X-ray tube voltage Haute tension nominale	49 kV	

I dati forniti nella presente documentazione si intendono riferiti a:

The data indicated in this documentation refer to:

Les données indiquées dans cette documentation sont calculées pour:

Potenza anodica di equilibrio termico		% della capacità termica anodica	
Equivalent anode input power	100 W =	% of maximum anode heat content	38%
Puissance anodique d'équilibre thermique		% de chaleur max. accumulée dans l'anode	

Dimensioni - Dimension - Dimensions

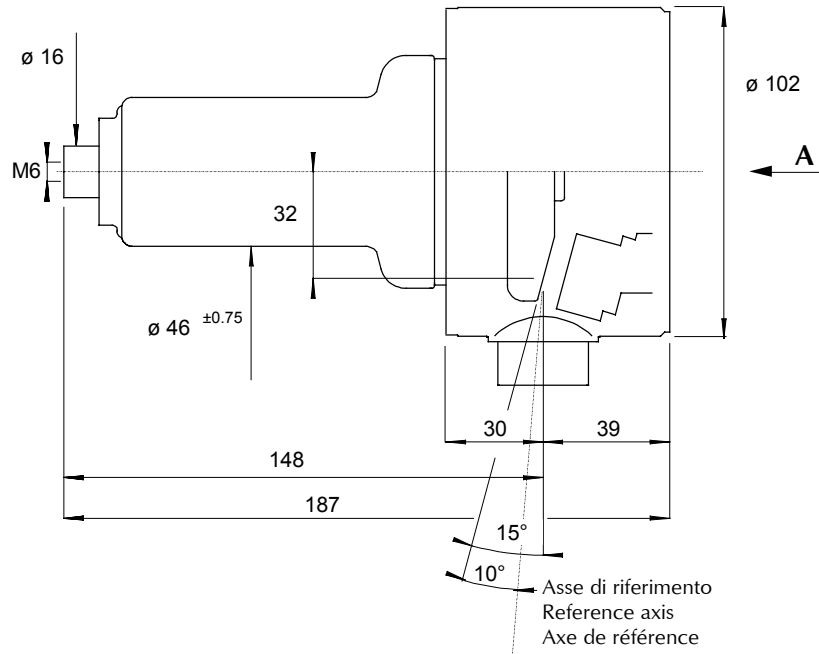

Vista A - View A - Vue A

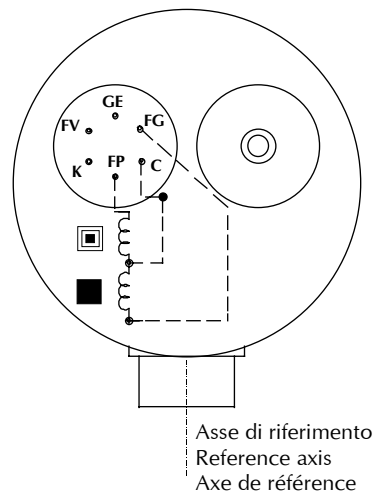

Collegamenti - Connector - Connexions

Fuoco piccolo	Small focal spot	Petit foyer	FP
Fuoco grande	Large focal spot	Grand foyer	FG
Comune <i>Deve essere collegato a terra o direttamente o attraverso il circuito di misura dei mA</i>	Common <i>Must be connected to ground either directly or through mA measurement circuit</i>	Commun <i>Doit être raccorder à la terre ou directement ou par le circuit de mesure des mA</i>	C
Utilizzati in fase di produzione	Used during working process	Utilisés pendant le procédé de production	K - FV - GE

Curva di raffreddamento dell'anodo
Anode cooling curve
Courbe de refroidissement de l'anode

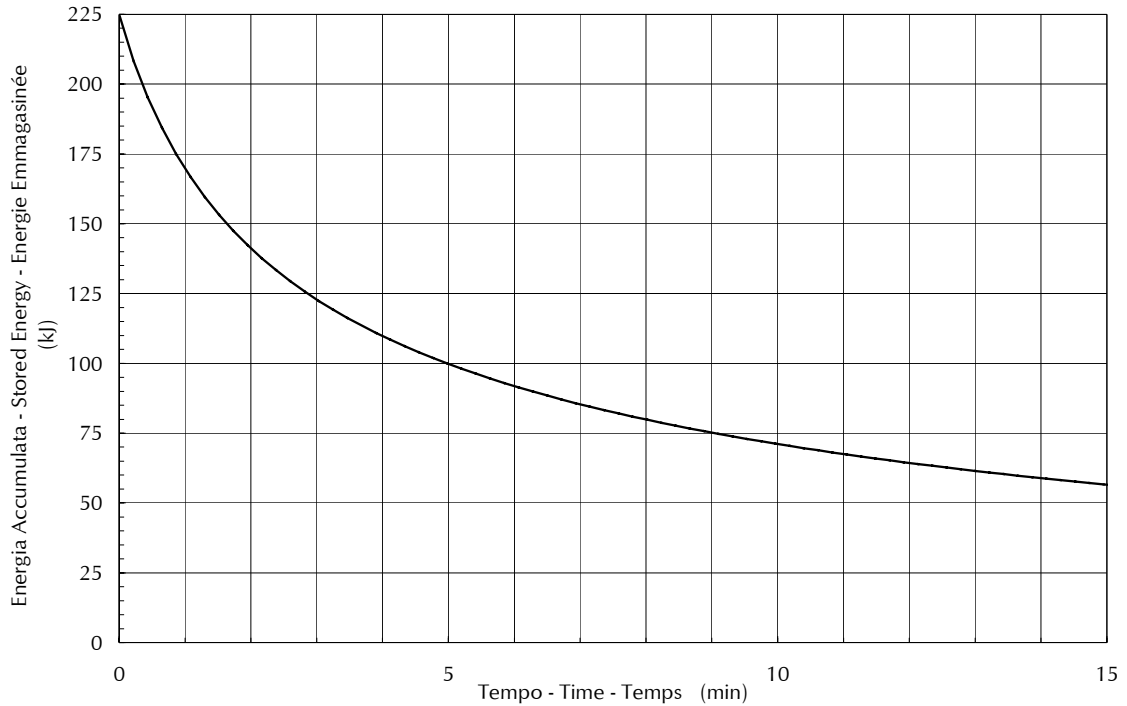

Curve di riscaldamento dell'anodo
Anode heating curves
Courbes d'échauffement de l'anode

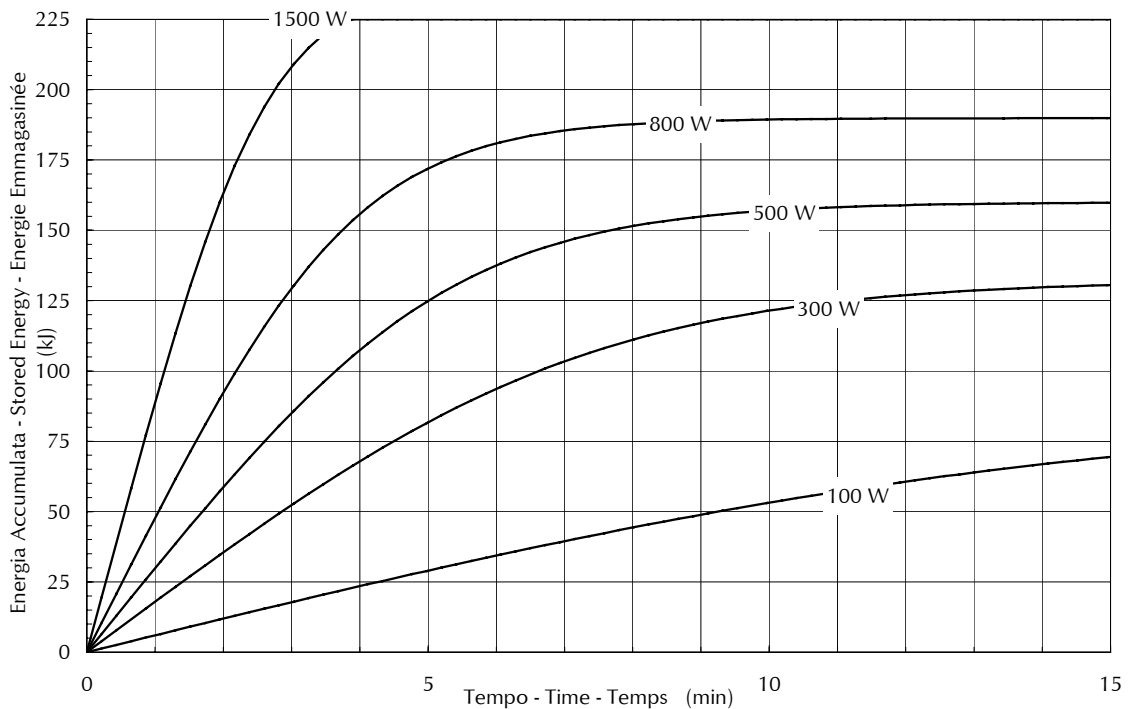



CURVE DI CARICO SINGOLO - SINGLE LOAD RATING - ABAQUE DE CHARGE UNIQUE

▣ 0.1 - 1 ~ - 3000 min⁻¹

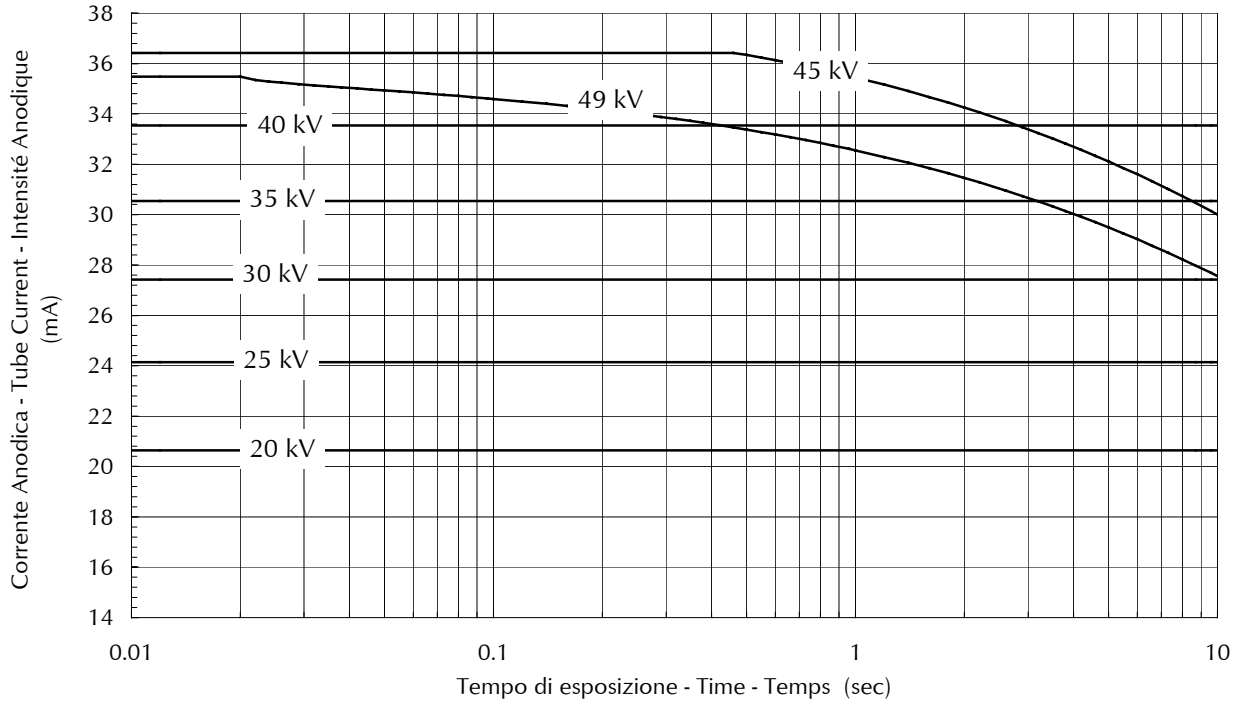

CURVE DI CARICO SINGOLO - SINGLE LOAD RATING - ABAQUE DE CHARGE UNIQUE

■ 0.3 - 1 ~ - 3000 min⁻¹

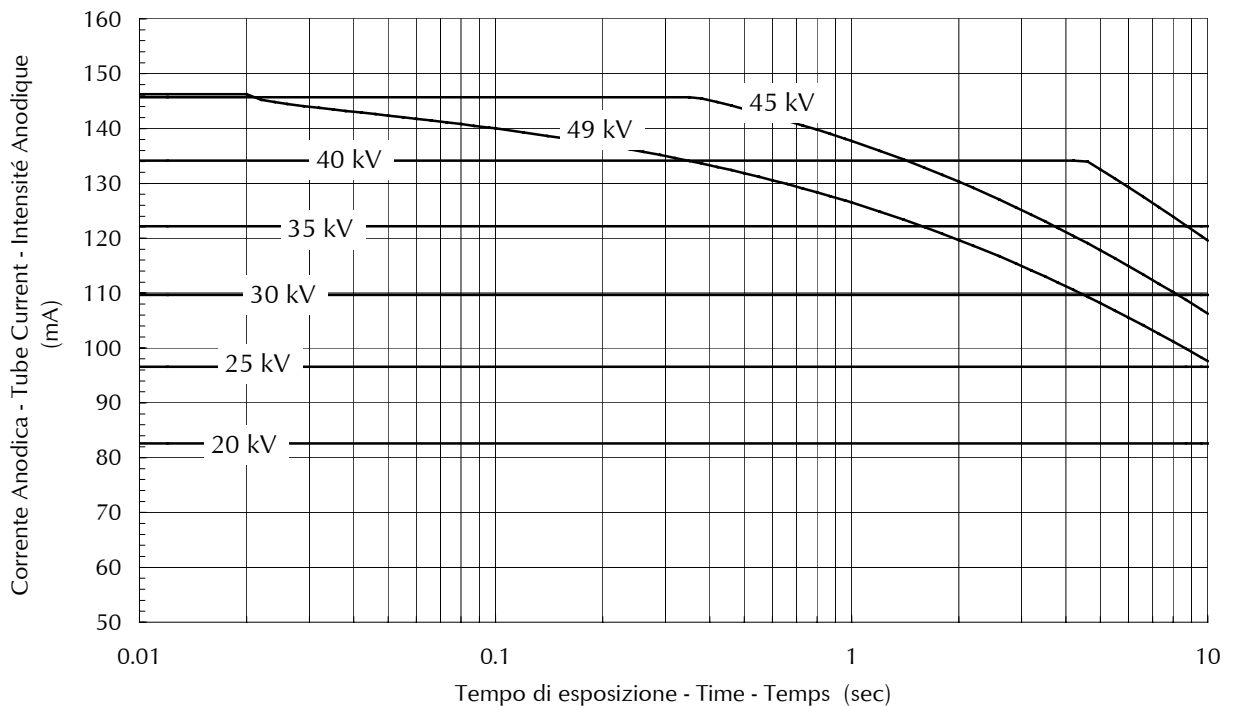



CURVE DI CARICO SINGOLO - SINGLE LOAD RATING - ABAQUE DE CHARGE UNIQUE

▣ 0.1 - 3 ~ - 3000 min⁻¹

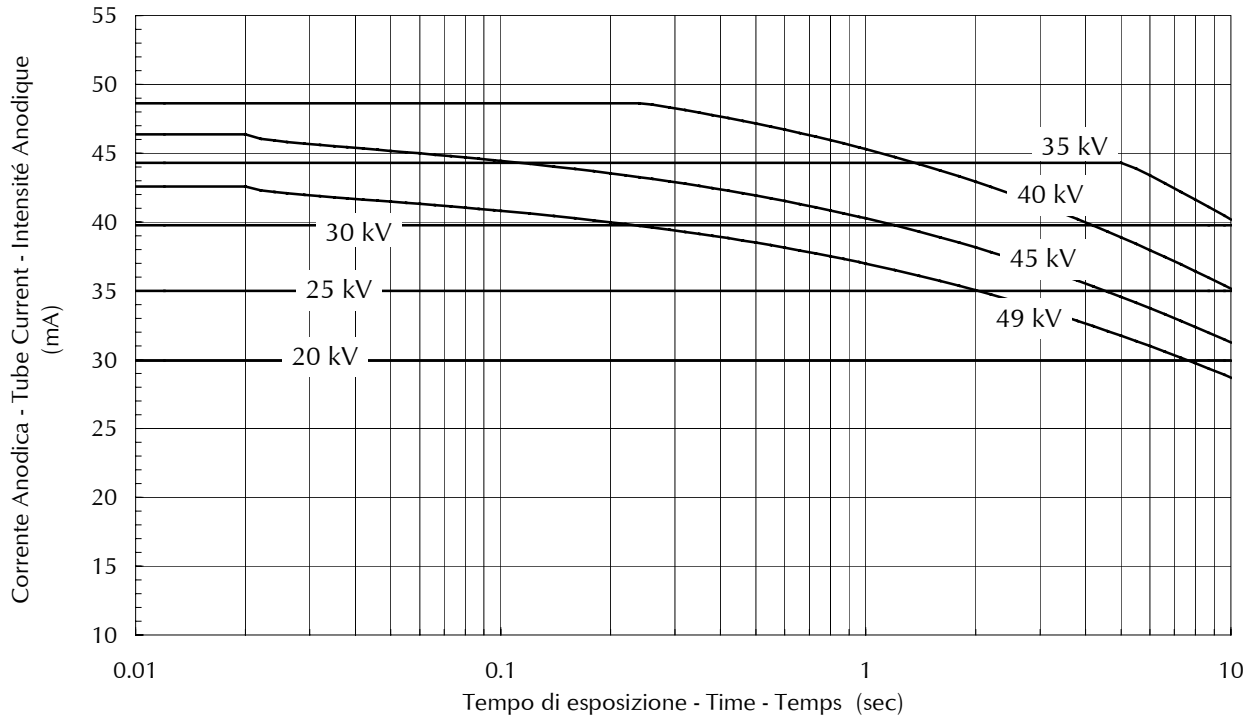

CURVE DI CARICO SINGOLO - SINGLE LOAD RATING - ABAQUE DE CHARGE UNIQUE

■ 0.3 - 3 ~ - 3000 min⁻¹

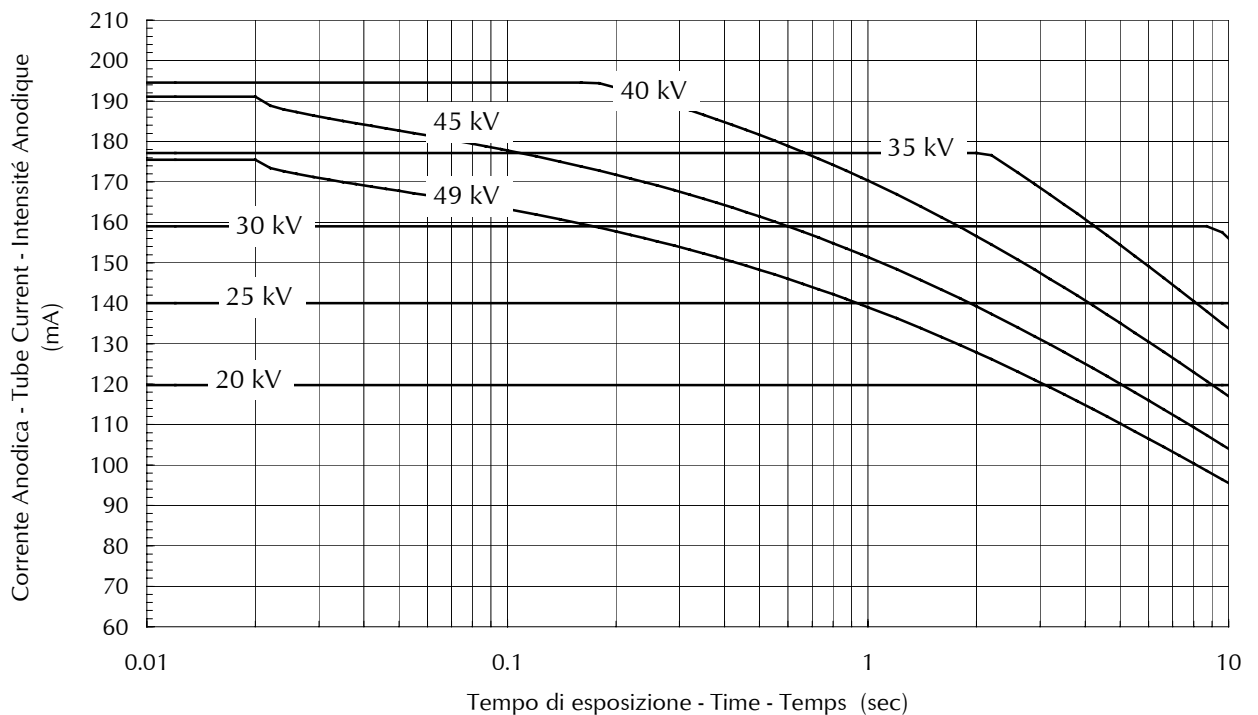



CURVE DI CARICO SINGOLO - SINGLE LOAD RATING - ABAQUE DE CHARGE UNIQUE

▣ 0.1 - 1 ~ - 10000 min⁻¹

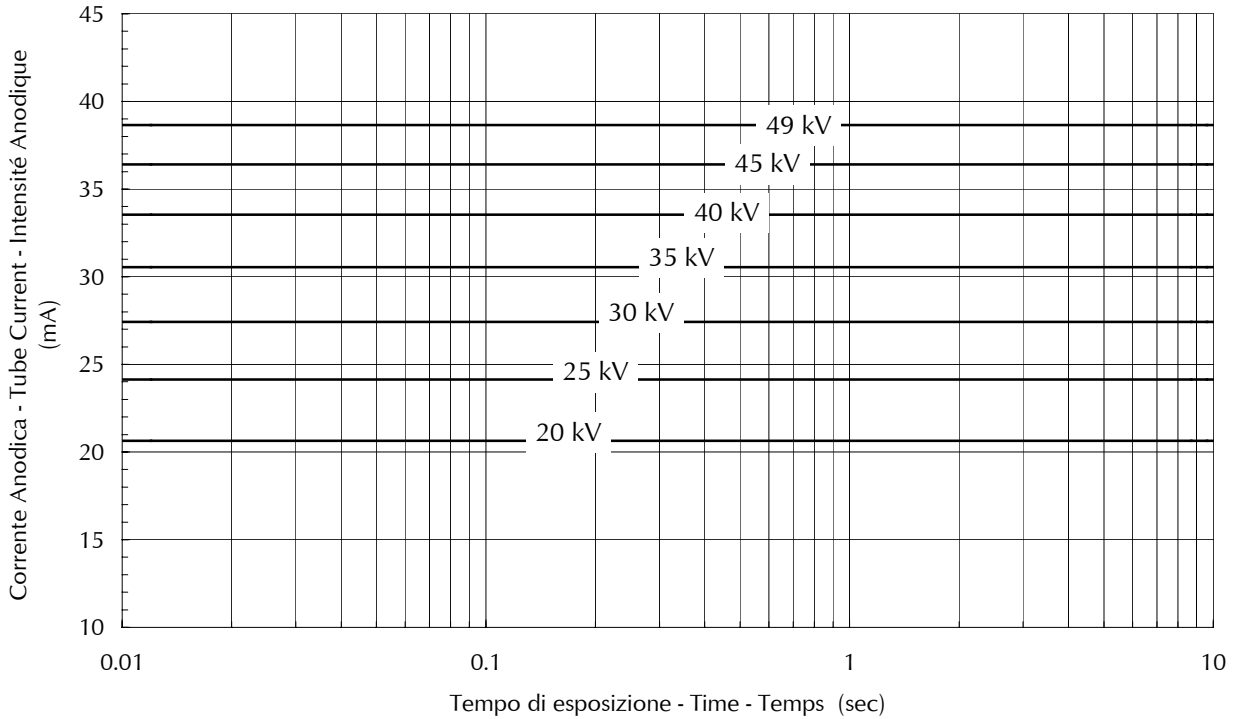

CURVE DI CARICO SINGOLO - SINGLE LOAD RATING - ABAQUE DE CHARGE UNIQUE

■ 0.3 - 1 ~ - 10000 min⁻¹

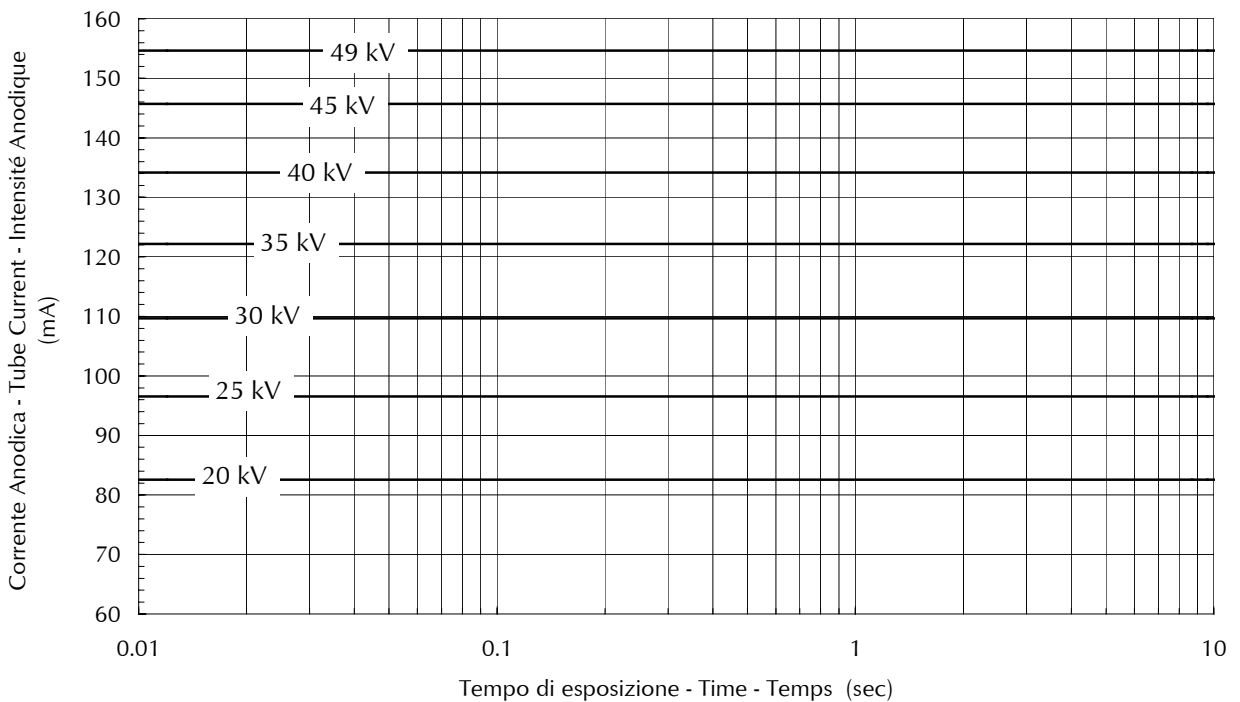



CURVE DI CARICO SINGOLO - SINGLE LOAD RATING - ABAQUE DE CHARGE UNIQUE

▣ 0.1 - 3 ~ - 10000 min⁻¹

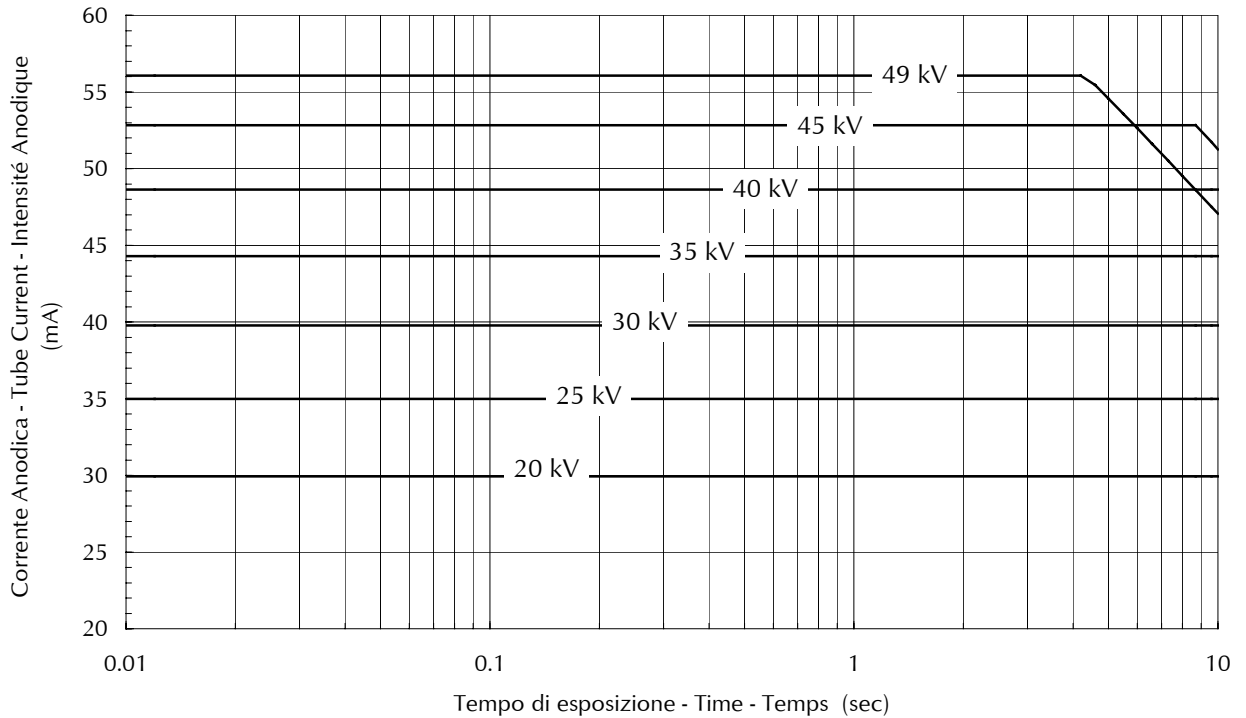

CURVE DI CARICO SINGOLO - SINGLE LOAD RATING - ABAQUE DE CHARGE UNIQUE

■ 0.3 - 3 ~ - 10000 min⁻¹

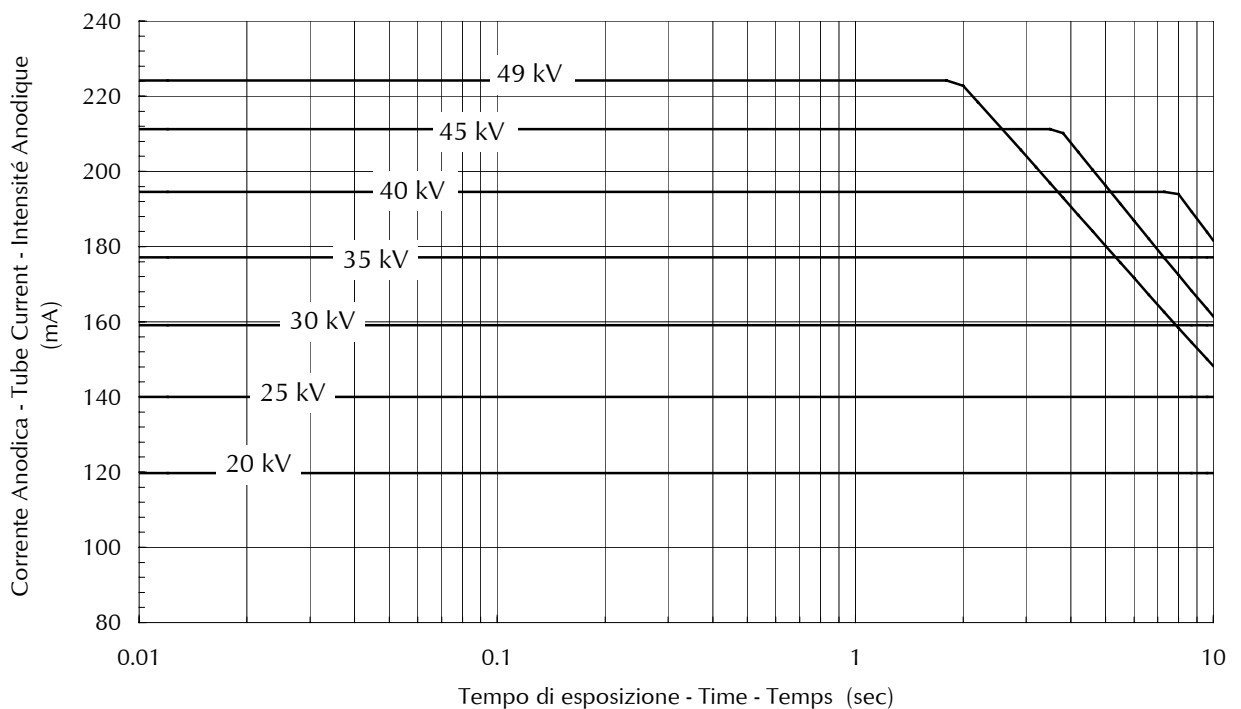

Caratteristica di emissione del catodo
Cathode emission characteristic
Caractéristique d'émission de la cathode

▣ 0.1 - 3 ~ - (± 0.2 A)

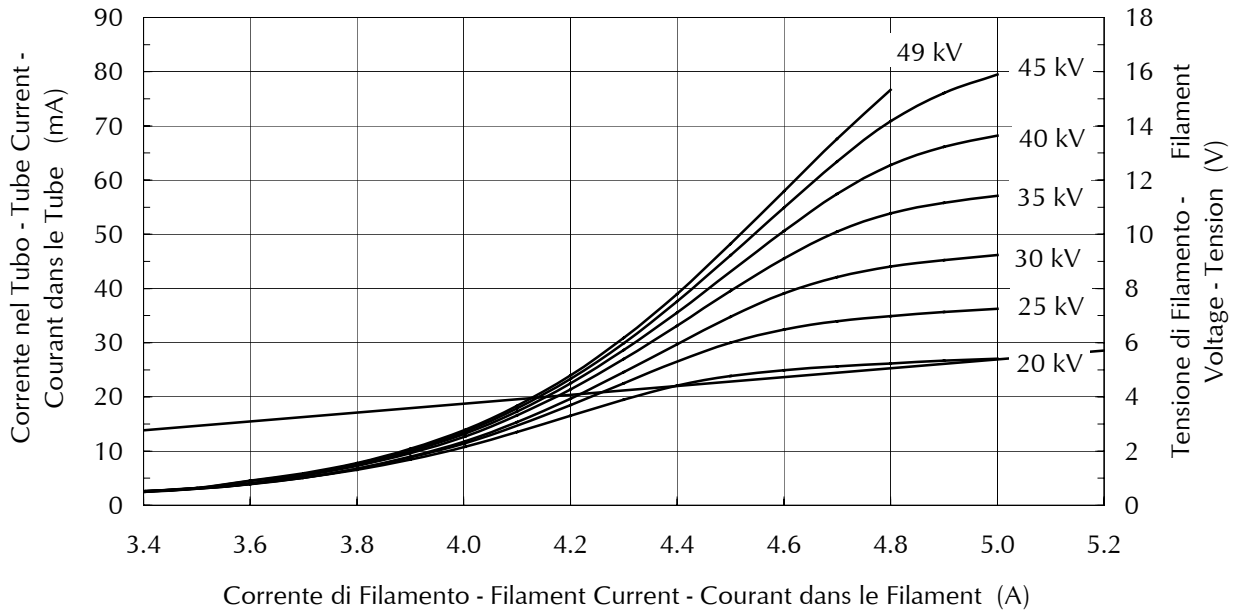

Caratteristica di emissione del catodo
Cathode emission characteristic
Caractéristique d'émission de la cathode

■ 0.3 - 3 ~ - (± 0.2 A)

