



Documentazione Tubo a raggi X

Tube Documentation

Documentation du Tube

RTM 78 HS 1.0/2.0

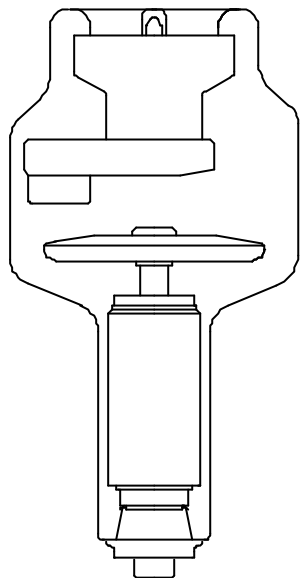

Nr. di matricola
Tube No.
Nr de série



Questa documentazione deve essere fornita all'utilizzatore del complesso tubo-guaina
The contents of this documentation must be transmitted to the user of the tube-assembly
Le contenu de cette documentation doit être transmis à l'utilisateur de la gaine équipée

Documentazione N° Documentation N° N° de Documentation	Revisione Edition Version	Data di edizione Date of release Date de l'édition	Testo originale Original text Texte original
78_SAK	0	15.10.98	italiano / italian / italien



















I.A.E Spa

via Fabio Filzi, 53 - 20032 CORMANO (MI) Italy
Tel: ++39-0266303255 Fax: ++39-026152544
<http://www.iae.it> e-mail: iaexray@iae.it





Sommario - Table of contents - Table des matières

Sommario - Table of contents - Table des matières.....	2
Caratteristiche - Specifications - Spécifications	3
Dimensioni - Dimension - Dimensions	4
Curve di riscaldamento e raffreddamento dell'anodo Anode heating and cooling curves Courbes d'échauffement et de refroidissement de l'anode.....	4
CURVE DI CARICO SINGOLO - SINGLE LOAD RATING - ABAQUE DE CHARGE UNIQUE  1.0 - 1 ~ - 3000 min ⁻¹	5
CURVE DI CARICO SINGOLO - SINGLE LOAD RATING - ABAQUE DE CHARGE UNIQUE  2.0 - 1 ~ - 3000 min ⁻¹	5
CURVE DI CARICO SINGOLO - SINGLE LOAD RATING - ABAQUE DE CHARGE UNIQUE  1.0 - 3 ~ - 3000 min ⁻¹	6
CURVE DI CARICO SINGOLO - SINGLE LOAD RATING - ABAQUE DE CHARGE UNIQUE  2.0 - 3 ~ - 3000 min ⁻¹	6
CURVE DI CARICO SINGOLO - SINGLE LOAD RATING - ABAQUE DE CHARGE UNIQUE  1.0 - 1 ~ - 10000 min ⁻¹	7
CURVE DI CARICO SINGOLO - SINGLE LOAD RATING - ABAQUE DE CHARGE UNIQUE  2.0 - 1 ~ - 10000 min ⁻¹	7
CURVE DI CARICO SINGOLO - SINGLE LOAD RATING - ABAQUE DE CHARGE UNIQUE  1.0 - 3 ~ - 10000 min ⁻¹	8
CURVE DI CARICO SINGOLO - SINGLE LOAD RATING - ABAQUE DE CHARGE UNIQUE  2.0 - 3 ~ - 10000 min ⁻¹	8
Abaco per carichi in serie - Serial load rating - Abaque de charges successives  1.0 - 1 ~ - 3000 min ⁻¹	9
Abaco per carichi in serie - Serial load rating - Abaque de charges successives  2.0 - 1 ~ - 3000 min ⁻¹	10
Abaco per carichi in serie - Serial load rating - Abaque de charges successives  1.0 - 3 ~ - 3000 min ⁻¹	11
Abaco per carichi in serie - Serial load rating - Abaque de charges successives  2.0 - 3 ~ - 3000 min ⁻¹	12
Abaco per carichi in serie - Serial load rating - Abaque de charges successives  1.0 - 1 ~ - 10000 min ⁻¹	13
Abaco per carichi in serie - Serial load rating - Abaque de charges successives  2.0 - 1 ~ - 10000 min ⁻¹	14
Abaco per carichi in serie - Serial load rating - Abaque de charges successives  1.0 - 3 ~ - 10000 min ⁻¹	15
Abaco per carichi in serie - Serial load rating - Abaque de charges successives  2.0 - 3 ~ - 10000 min ⁻¹	16
Caratteristica di emissione del catodo Cathode emission characteristic Caractéristique d'émission de la cathode  1.0 - 3 ~ - (± 0.2 A).....	17
Caratteristica di emissione del catodo Cathode emission characteristic Caractéristique d'émission de la cathode  2.0 - 3 ~ - (± 0.2 A).....	17

Dichiarazione di conformità

Questo prodotto soddisfa i requisiti essenziali della direttiva 93/42/CEE in
accordo alle norme EN 60613 (IEC 613) e EN 60336 (IEC 336)

Declaration of conformity





This tube fulfils the essential requirements of the directive 93/42/EEC
according to standard EN 60613 (IEC 613) and EN 60336 (IEC 336).

Confirmation de conformité

Ce tube remplit les exigences essentielles de la directive 93/42/CEE en
accord avec les normes EN 60613 (IEC 613) et EN 60336 (IEC 336).



Caratteristiche - Specifications - Spécifications

Macchie focali Focal spot Foyer	 1.0  2.0		(IEC 336, EN 60336)
Velocità di rotazione dell'anodo Anode speed Vitesse de l'anode		3000 min ⁻¹ 10000 min ⁻¹	
Potenza anodica nominale Nominal anode input power Puissance anodique nominale	 24 kW  48 kW	43 kW 85 kW	(IEC 613, EN 60613)
Diametro anodico Anode diameter Diamètre de l'anode		73 mm	
Materiale anodico Anode material Materiau de l'anode		RTM	
Angolo anodico Anode angle Pente de l'anode		15 °	
Campo di radiazione Radiation field Champ de rayonnement		a 70 cm 36 cm a 100 cm 50 cm	
Filtrazione inerente Inherent filtration Filtration inhérente		0.7 mm Al eq	(IEC 522)
Capacità termica anodica Maximum anode heat content Chaleur maximale accumulée dans l'anode		225 kJ 300 kHU	
Dissipazione termica continua massima Maximum continuous heat dissipation Dissipation thermique continue maximale		750 W	
Alta tensione nominale Nominal X-ray tube voltage Haute tension nominale		150 kV	
Massima corrente di filamento Max. filament current Courant dans le filament max.		5.4 A	

I dati forniti nella presente documentazione si intendono riferiti a:

The data indicated in this documentation refer to:

Les données indiquées dans cette documentation sont calculées pour:

Potenza anodica di equilibrio termico

Equivalent anode input power

Puissance anodique d'équilibre thermique

100 W =

% della capacità termica anodica

% of maximum anode heat content

% de chaleur max. accumulée dans l'anode

38%

Dimensioni - Dimension - Dimensions

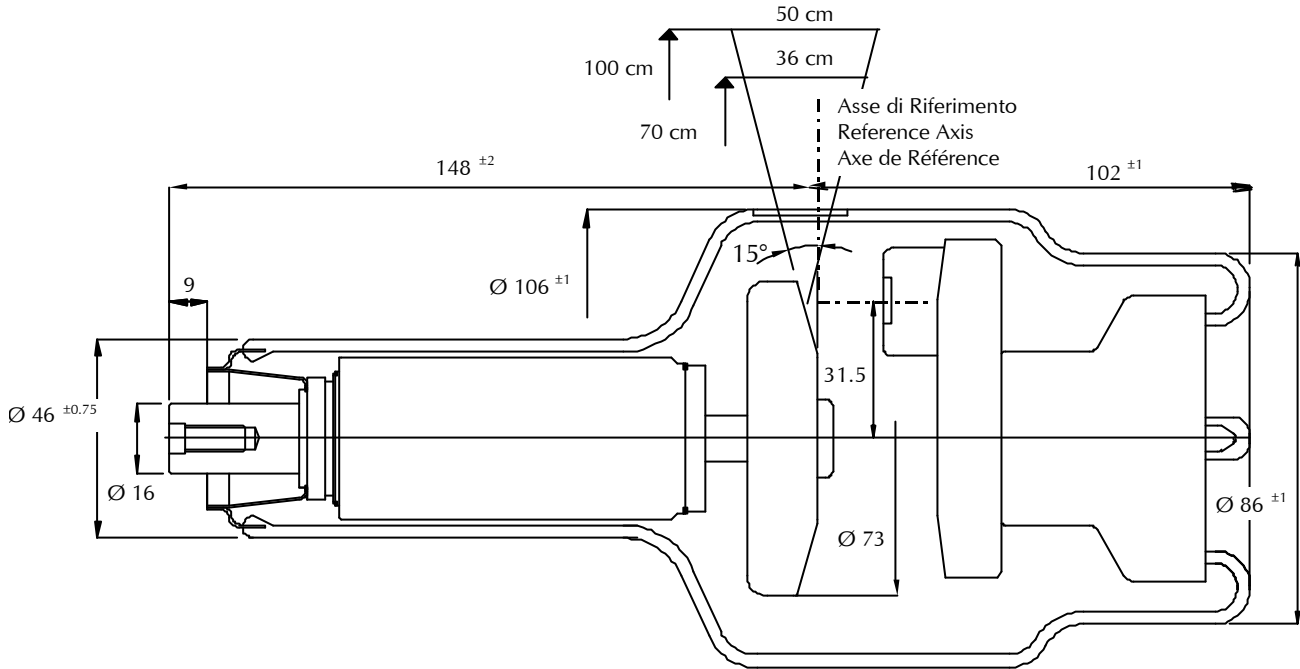

Curve di riscaldamento e raffreddamento dell'anodo Anode heating and cooling curves Courbes d'échauffement et de refroidissement de l'anode

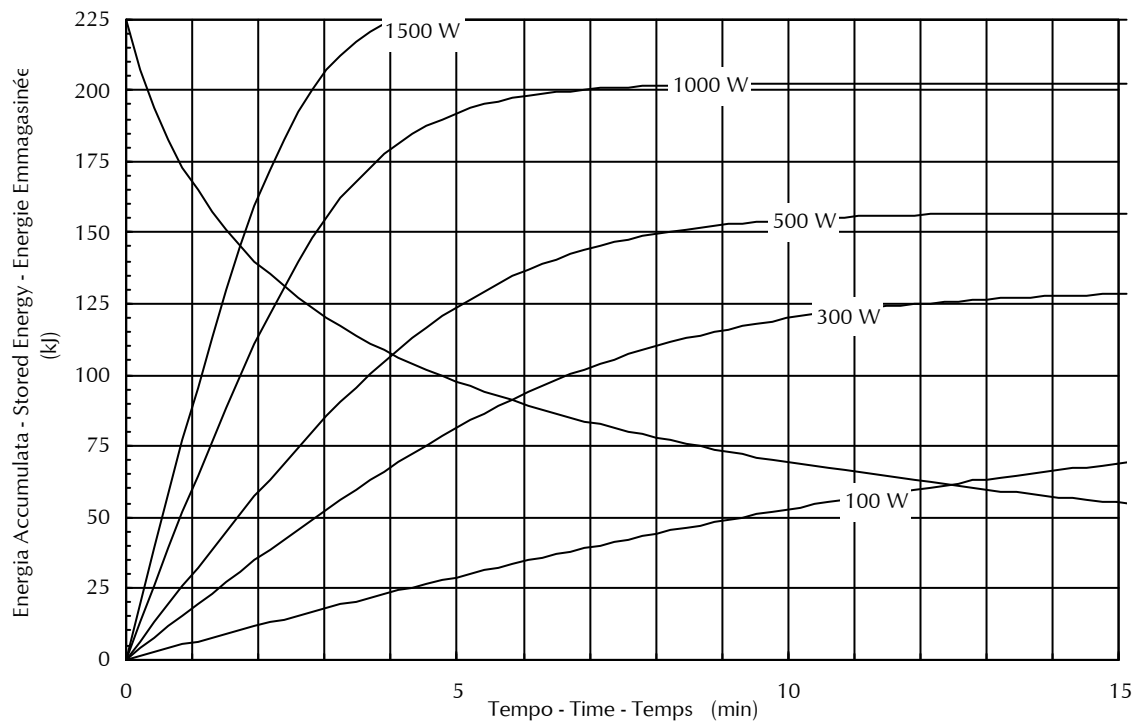



CURVE DI CARICO SINGOLO - SINGLE LOAD RATING - ABAQUE DE CHARGE UNIQUE

▣ 1.0 - 1 ~ - 3000 min⁻¹

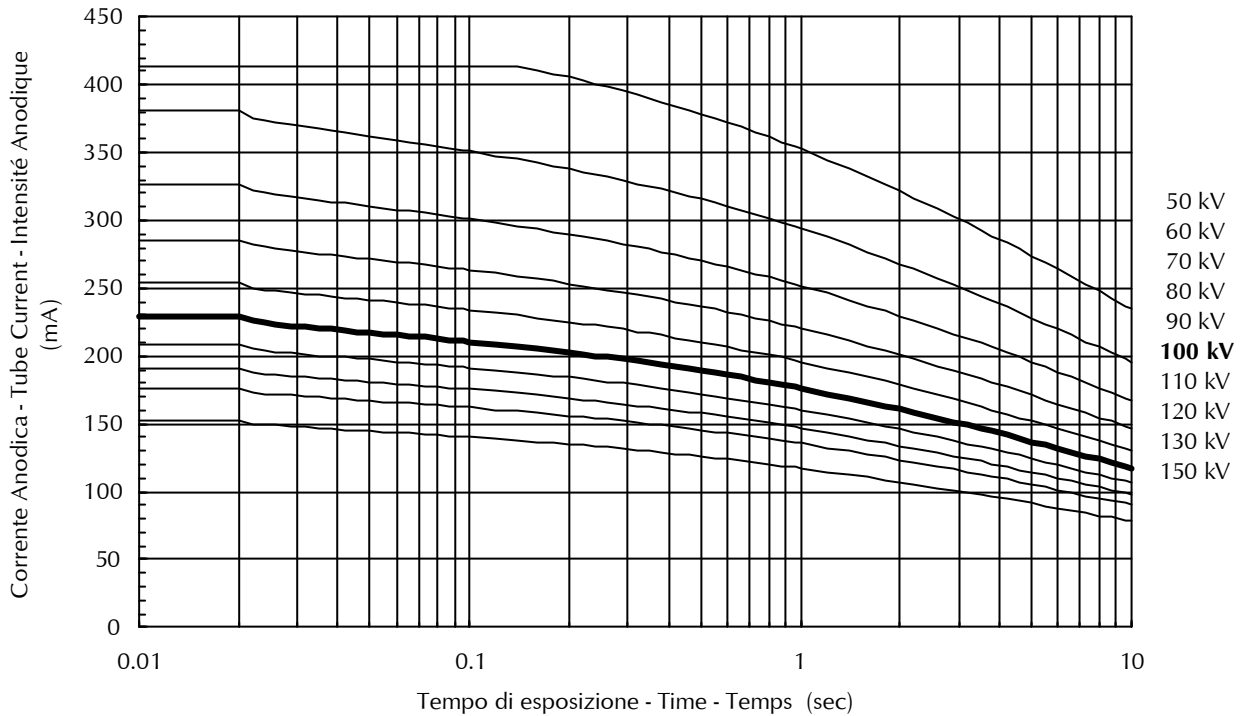

CURVE DI CARICO SINGOLO - SINGLE LOAD RATING - ABAQUE DE CHARGE UNIQUE

■ 2.0 - 1 ~ - 3000 min⁻¹

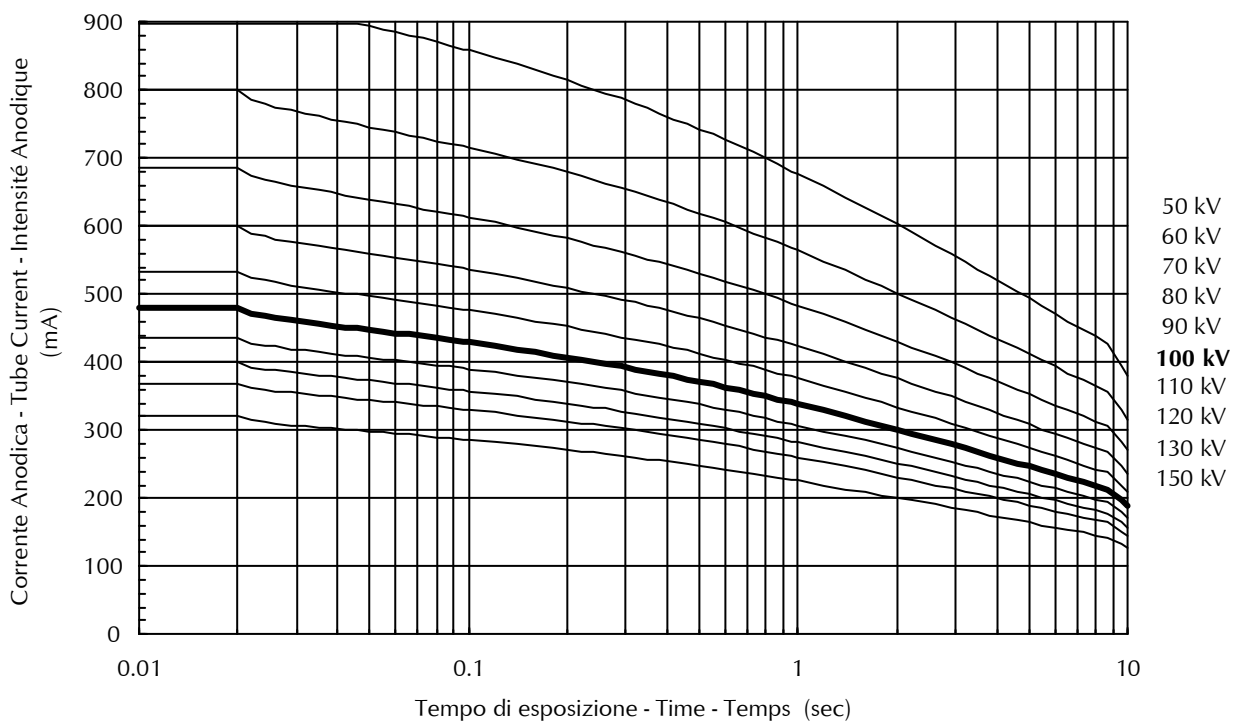



CURVE DI CARICO SINGOLO - SINGLE LOAD RATING - ABAQUE DE CHARGE UNIQUE

▣ 1.0 - 3 ~ - 3000 min⁻¹

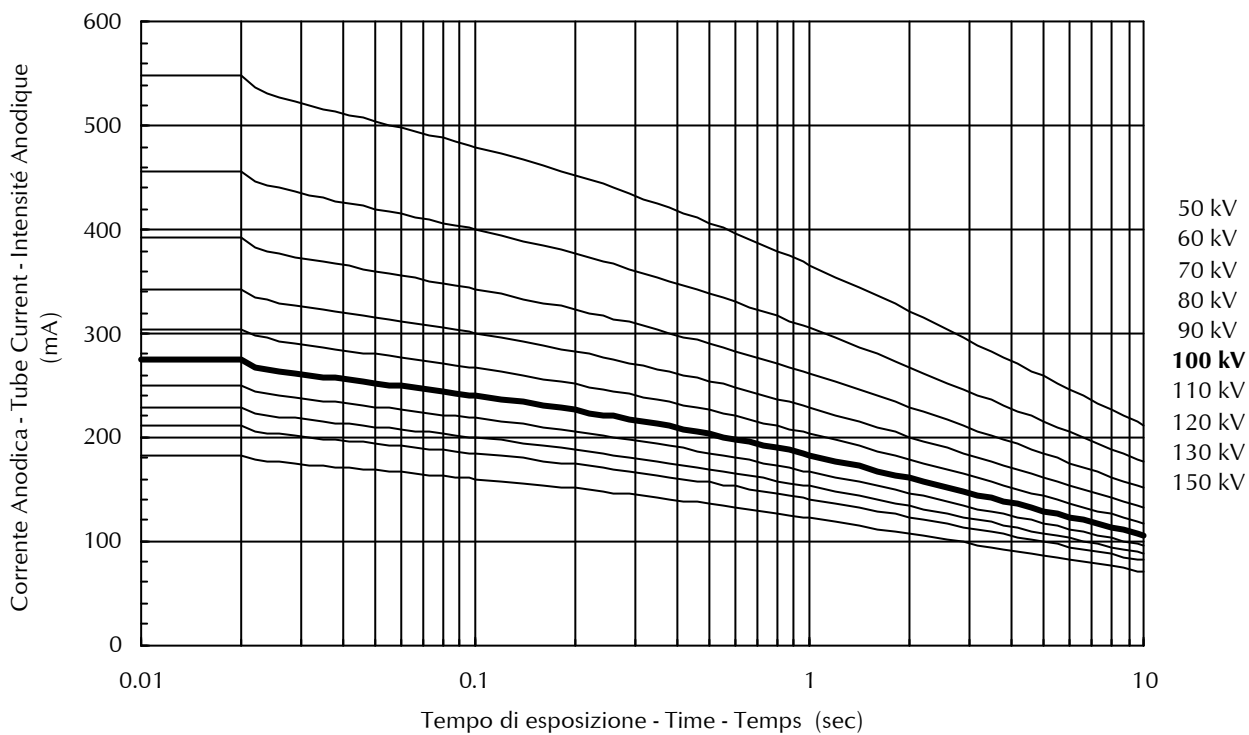

CURVE DI CARICO SINGOLO - SINGLE LOAD RATING - ABAQUE DE CHARGE UNIQUE

■ 2.0 - 3 ~ - 3000 min⁻¹

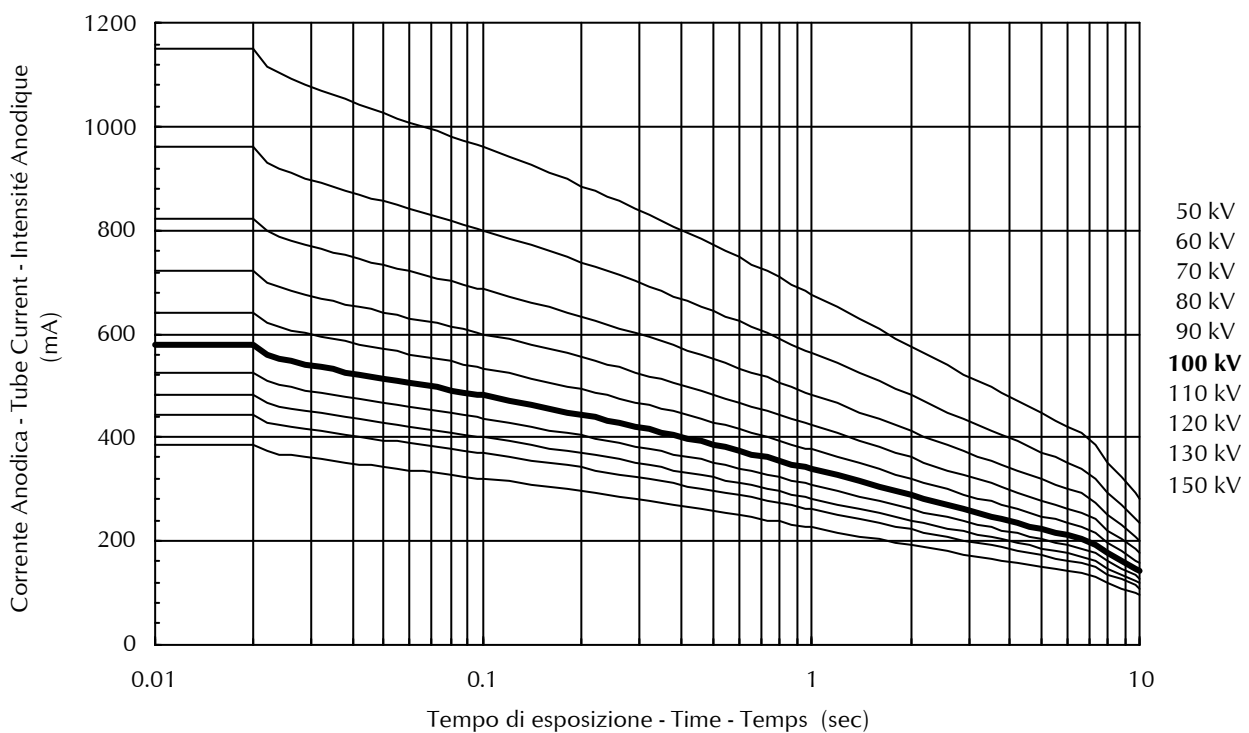



CURVE DI CARICO SINGOLO - SINGLE LOAD RATING - ABAQUE DE CHARGE UNIQUE

▣ 1.0 - 1 ~ - 10000 min⁻¹

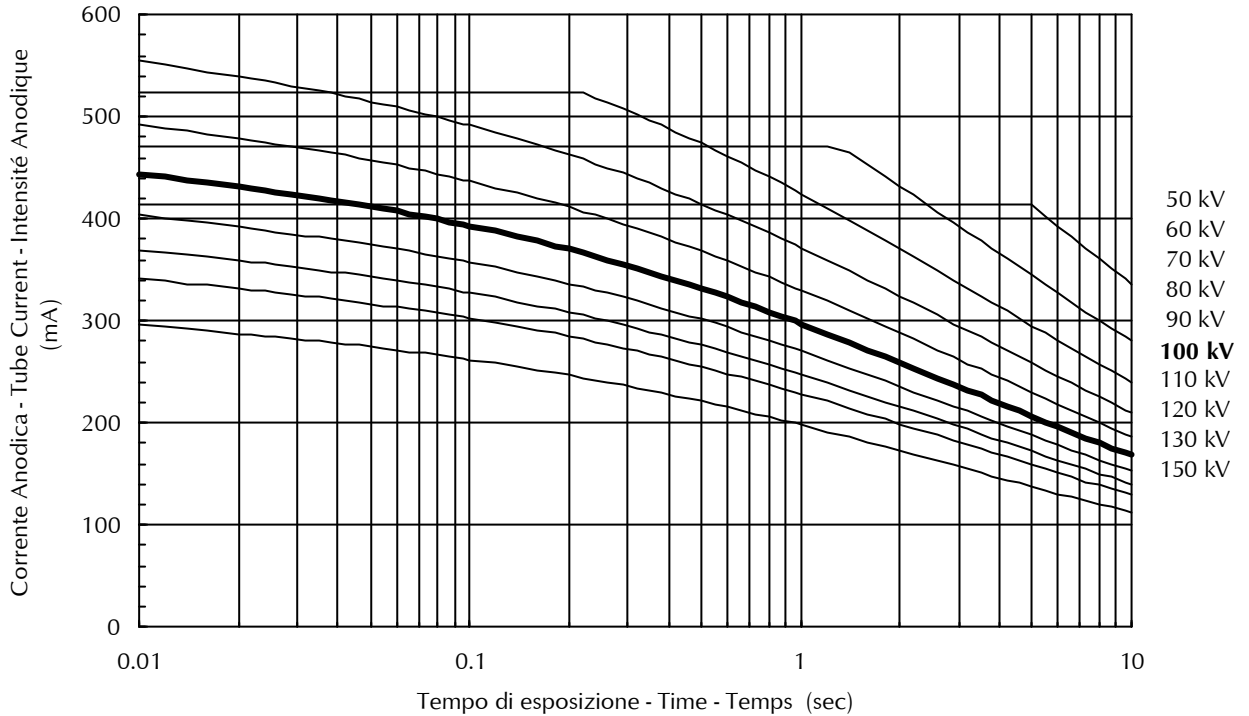

CURVE DI CARICO SINGOLO - SINGLE LOAD RATING - ABAQUE DE CHARGE UNIQUE

■ 2.0 - 1 ~ - 10000 min⁻¹

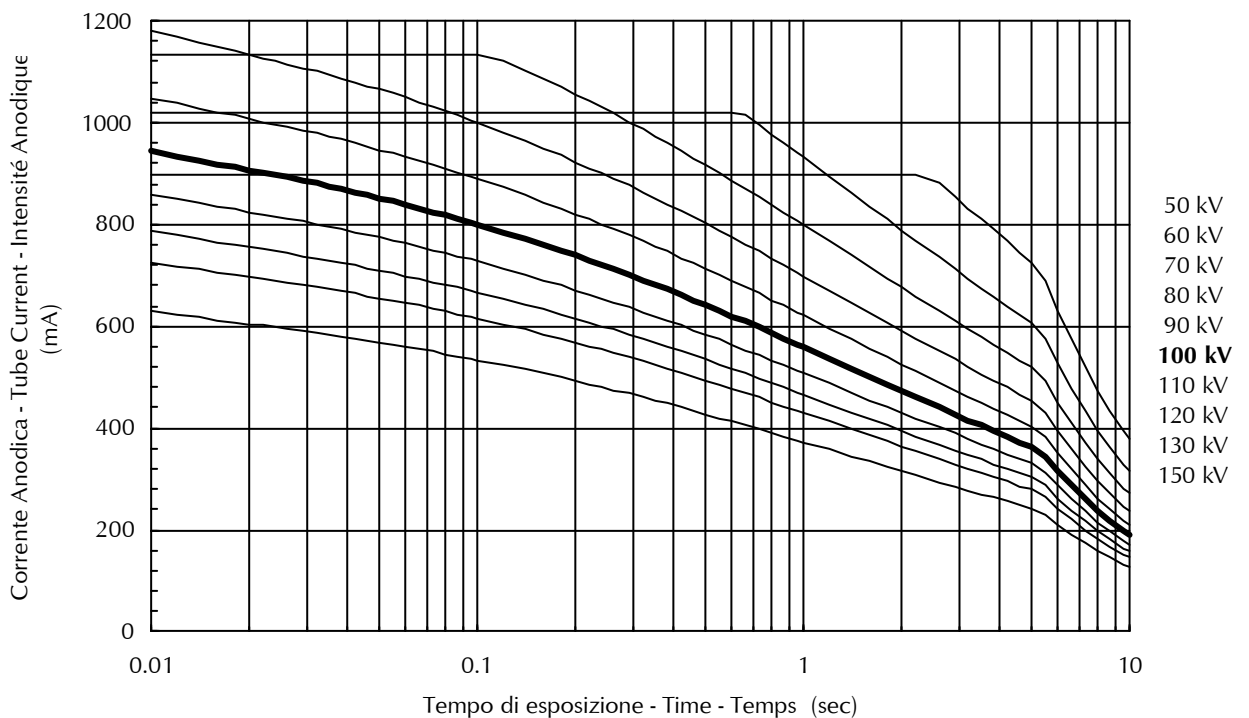



CURVE DI CARICO SINGOLO - SINGLE LOAD RATING - ABAQUE DE CHARGE UNIQUE

▣ 1.0 - 3 ~ - 10000 min⁻¹

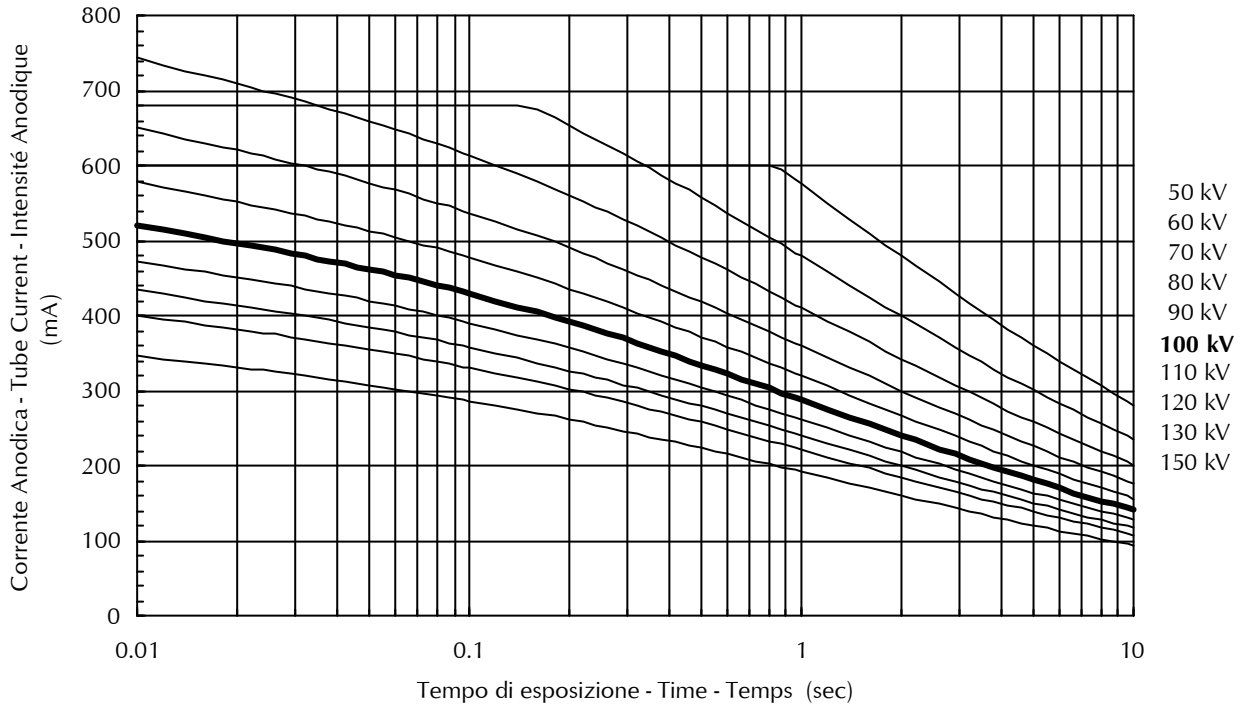

CURVE DI CARICO SINGOLO - SINGLE LOAD RATING - ABAQUE DE CHARGE UNIQUE

■ 2.0 - 3 ~ - 10000 min⁻¹

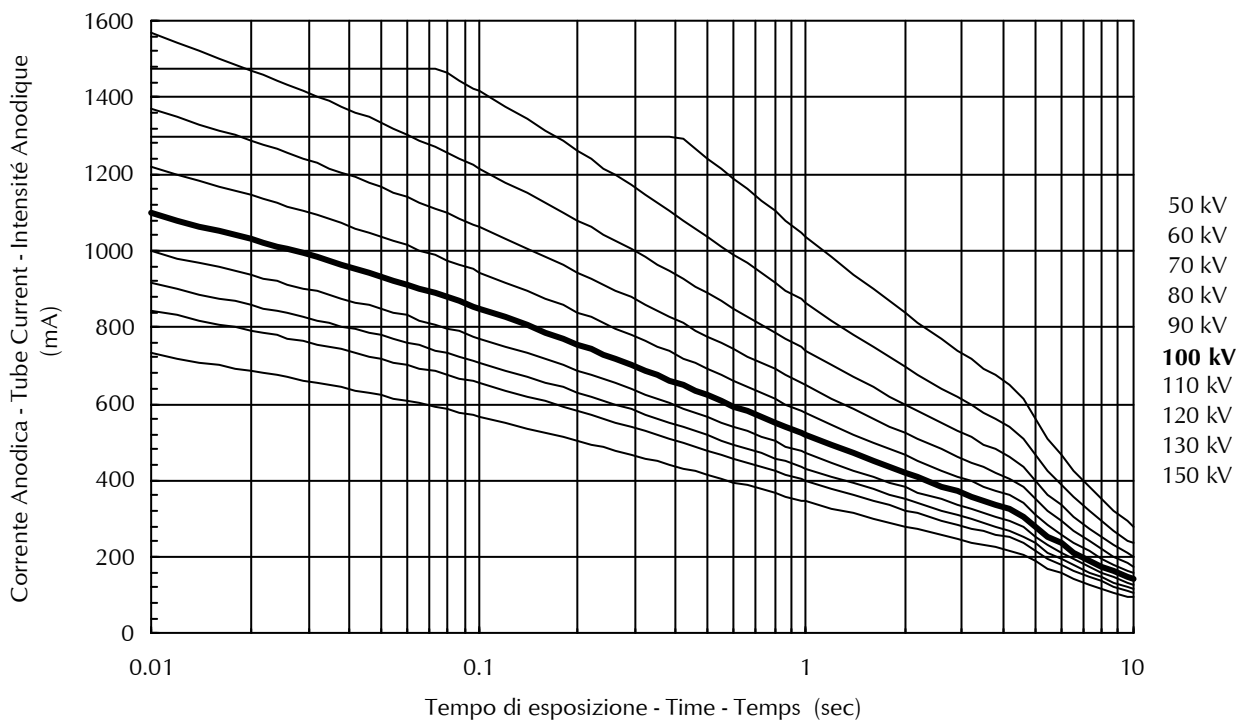



Abaco per carichi in serie - Serial load rating - Abaque de charges successives

▣ 1.0 - 1 ~ - 3000 min⁻¹

Potenza ammessa sul tubo in kW, per serie di n esposizioni, con frequenza z e durata di ogni esposizione in sec Anode input power as a function of n (N° of exposures in series), z (exp. rate per sec), the exposure time (sec) Puissance anodique en fonction de n (N° d'exp. de la séries), z (cadence d'exp. par sec), temps d'exposition (sec)																
z	0.010	0.020	0.030	0.040	0.050	0.060	0.080	0.100	0.120	0.140	0.160	0.180	0.200	0.220	0.250	n
1	17.9	17.9	17.5	17.3	17.0	16.9	16.6	16.3	16.1	16.0	15.8	15.6	15.4	15.2	14.8	5
2	17.8	17.8	17.5	17.3	17.0	16.9	16.5	16.1	15.8	15.4	15.1	14.8	14.5	14.2	13.7	
3	17.7	17.7	17.4	17.2	16.9	16.7	16.2	15.7	15.3	14.9	14.5	14.2	13.8	13.5	13.0	
4	17.6	17.6	17.3	17.0	16.7	16.4	15.9	15.4	14.9	14.5	14.1	13.7	13.3	13.0	12.5	
5	17.5	17.5	17.2	16.9	16.6	16.3	15.7	15.1	14.6	14.2	13.7	13.3	12.9	-	-	
10	17.5	17.3	16.8	16.4	16.0	15.6	14.8	14.2	-	-	-	-	-	-	-	
15	17.5	17.1	16.5	16.0	15.5	15.1	-	-	-	-	-	-	-	-	-	
30	17.4	16.7	16.0	-	-	-	-	-	-	-	-	-	-	-	-	
1	17.8	17.8	17.5	17.3	17.0	16.9	16.5	16.1	15.8	15.4	15.1	14.8	14.5	14.2	13.7	10
2	17.6	17.6	17.3	17.0	16.7	16.4	15.9	15.4	14.9	14.5	14.1	13.7	13.3	12.9	12.5	
3	17.5	17.5	17.1	16.7	16.4	16.1	15.4	14.9	14.3	13.8	13.4	12.9	12.5	12.2	11.6	
4	17.5	17.4	16.9	16.5	16.1	15.8	15.1	14.5	13.9	13.3	12.9	12.4	12.0	11.6	11.0	
5	17.5	17.3	16.8	16.3	15.9	15.5	14.8	14.1	13.5	12.9	12.4	11.9	11.5	-	-	
10	17.5	16.9	16.3	15.7	15.1	14.6	13.7	12.9	-	-	-	-	-	-	-	
15	17.4	16.6	15.9	15.2	14.6	14.0	-	-	-	-	-	-	-	-	-	
30	17.1	16.0	15.1	-	-	-	-	-	-	-	-	-	-	-	-	
1	17.6	17.6	17.3	17.0	16.7	16.4	15.9	15.4	14.9	14.5	14.1	13.7	13.3	12.9	12.4	20
2	17.5	17.4	16.9	16.5	16.1	15.8	15.1	14.5	13.9	13.3	12.8	12.4	11.9	11.6	11.0	
3	17.5	17.2	16.7	16.2	15.7	15.3	14.5	13.8	13.2	12.6	12.0	11.5	11.1	10.7	10.1	
4	17.5	17.0	16.4	15.9	15.4	14.9	14.1	13.3	12.6	12.0	11.4	10.9	10.5	10.0	9.4	
5	17.5	16.9	16.2	15.7	15.1	14.6	13.7	12.9	12.2	11.5	11.0	10.4	10.0	-	-	
10	17.3	16.3	15.5	14.8	14.1	13.5	12.4	11.5	-	-	-	-	-	-	-	
15	17.0	16.0	15.0	14.2	13.4	12.8	-	-	-	-	-	-	-	-	-	
30	16.6	15.2	14.0	-	-	-	-	-	-	-	-	-	-	-	-	
1	17.5	17.4	16.9	16.5	16.1	15.8	15.1	14.4	13.9	13.3	12.8	12.4	11.9	11.5	11.0	40
2	17.5	17.0	16.4	15.9	15.4	14.9	14.1	13.3	12.6	12.0	11.4	10.9	10.4	10.0	9.4	
3	17.5	16.7	16.1	15.4	14.9	14.3	13.4	12.5	11.8	11.1	10.5	10.0	9.5	9.1	8.5	
4	17.4	16.5	15.8	15.1	14.5	13.9	12.8	11.9	11.2	10.5	9.9	9.4	8.9	8.4	7.9	
5	17.3	16.3	15.5	14.8	14.1	13.5	12.4	11.5	10.7	10.0	9.4	8.9	8.4	-	-	
10	16.9	15.7	14.6	13.7	12.9	12.2	11.0	10.0	-	-	-	-	-	-	-	
15	16.6	15.2	14.0	13.0	12.1	11.3	-	-	-	-	-	-	-	-	-	
30	16.0	14.2	12.8	-	-	-	-	-	-	-	-	-	-	-	-	
1	17.5	17.2	16.7	16.2	15.7	15.3	14.5	13.8	13.2	12.6	12.0	11.5	11.1	10.5	9.2	60
2	17.5	16.7	16.1	15.4	14.9	14.3	13.4	12.5	11.8	11.1	10.5	10.0	9.5	9.1	8.4	
3	17.3	16.4	15.6	14.9	14.3	13.7	12.6	11.7	10.9	10.2	9.6	9.1	8.6	8.2	7.6	
4	17.2	16.2	15.3	14.5	13.8	13.2	12.0	11.1	10.3	9.6	9.0	8.4	8.0	7.5	7.0	
5	17.0	16.0	15.0	14.2	13.4	12.7	11.6	10.6	9.8	9.1	8.5	7.9	7.5	-	-	
10	16.6	15.2	14.0	13.0	12.1	11.3	10.0	9.0	-	-	-	-	-	-	-	
15	16.2	14.6	13.3	12.2	11.2	10.4	-	-	-	-	-	-	-	-	-	
30	15.5	13.5	11.9	-	-	-	-	-	-	-	-	-	-	-	-	
1	17.5	17.0	16.4	15.9	15.4	14.9	14.1	13.3	12.6	12.0	11.4	10.2	9.2	8.4	7.4	80
2	17.4	16.5	15.8	15.1	14.4	13.9	12.8	11.9	11.2	10.5	9.9	9.0	8.1	7.4	6.5	
3	17.2	16.2	15.3	14.5	13.8	13.2	12.0	11.1	10.3	9.6	9.0	8.4	7.7	7.0	6.2	
4	17.0	15.9	14.9	14.1	13.3	12.6	11.4	10.4	9.6	8.9	8.3	7.8	7.3	6.9	6.1	
5	16.9	15.7	14.6	13.7	12.9	12.2	10.9	9.9	9.1	8.4	7.8	7.3	6.8	-	-	
10	16.3	14.8	13.5	12.4	11.5	10.7	9.4	8.4	-	-	-	-	-	-	-	
15	16.0	14.2	12.7	11.6	10.6	9.8	-	-	-	-	-	-	-	-	-	
30	15.2	13.0	11.3	-	-	-	-	-	-	-	-	-	-	-	-	
1	17.5	16.9	16.2	15.7	15.1	14.6	13.7	12.9	12.2	11.1	9.7	8.7	7.8	7.1	6.2	100
2	17.3	16.3	15.5	14.8	14.1	13.5	12.4	11.5	10.7	9.6	8.4	7.5	6.7	6.1	5.4	
3	17.0	16.0	15.0	14.2	13.4	12.7	11.6	10.6	9.8	9.1	7.9	7.0	6.3	5.8	5.1	
4	16.9	15.7	14.6	13.7	12.9	12.2	10.9	9.9	9.1	8.4	7.7	6.8	6.2	5.6	4.9	
5	16.7	15.4	14.3	13.3	12.4	11.7	10.4	9.4	8.6	7.9	7.3	6.7	6.1	-	-	
10	16.1	14.5	13.1	11.9	11.0	10.2	8.9	7.9	-	-	-	-	-	-	-	
15	15.7	13.8	12.3	11.1	10.1	9.3	-	-	-	-	-	-	-	-	-	
30	14.9	12.5	10.8	-	-	-	-	-	-	-	-	-	-	-	-	
1	17.4	16.6	15.8	15.2	14.5	14.0	13.0	11.8	9.9	8.5	7.4	6.6	5.9	5.4	4.7	150
2	17.0	16.0	15.0	14.2	13.4	12.7	11.6	9.7	8.1	6.9	6.0	5.4	4.8	4.4	3.9	
3	16.8	15.5	14.4	13.5	12.7	11.9	10.7	8.9	7.5	6.4	5.6	5.0	4.5	4.1	3.6	
4	16.6	15.2	14.0	13.0	12.1	11.3	10.0	8.6	7.1	6.1	5.4	4.8	4.3	3.9	3.4	
5	16.4	14.9	13.6	12.5	11.6	10.8	9.5	8.4	7.0	6.0	5.2	4.6	4.2	-	-	
10	15.7	13.8	12.3	11.1	10.1	9.3	8.0	7.0	-	-	-	-	-	-	-	
15	15.2	13.1	11.5	10.2	9.2	8.3	-	-	-	-	-	-	-	-	-	
30	14.3	11.7	9.9	-	-	-	-	-	-	-	-	-	-	-	-	
1	17.0	16.0	15.0	14.2	13.4	12.7	10.1	8.1	6.8	5.8	5.1	4.5	4.1	3.7	3.2	300
2	16.6	15.2	14.0	13.0	11.8	9.9	7.4	5.9	4.9	4.2	3.7	3.3	3.0	2.7	2.4	
3	16.2	14.6	13.3	12.2	10.4	8.7	6.5	5.2	4.3	3.7	3.2	2.9	2.6	2.4	2.1	
4	16.0	14.2	12.7	11.6	9.7	8.1	6.0	4.8	4.0	3.5	3.0	2.7	2.4	2.2	1.9	
5	15.7	13.8	12.3	11.1	9.2	7.7	5.8	4.6	3.8	3.3	2.9	2.6	2.3	-	-	
10	14.9	12.5	10.8	9.5	8.4	7.0	5.2	4.2	-	-	-	-	-	-	-	
15	14.3	11.7	9.9	8.6	7.6	6.7	-	-	-	-	-	-	-	-	-	
30	13.1	10.2	8.3	-	-	-	-	-	-	-	-	-	-	-	-	



Abaco per carichi in serie - Serial load rating - Abaque de charges successives

■ 2.0 - 1 ~ - 3000 min⁻¹

Potenza ammessa sul tubo in kW, per serie di n esposizioni, con frequenza z e durata di ogni esposizione in sec																
Anode input power as a function of n (N° of exposures in series), z (exp. rate per sec), the exposure time (sec)																
Puissance anodique en fonction de n (N° d'exp. de la série), z (cadence d'exp. par sec), temps d'exposition (sec)																
z	0.010	0.020	0.030	0.040	0.050	0.060	0.080	0.100	0.120	0.140	0.160	0.180	0.200	0.220	0.250	n
1	37.4	37.4	36.3	35.5	34.9	34.4	33.6	32.9	32.4	31.9	31.5	31.0	30.4	29.8	28.9	5
2	37.1	37.1	36.3	35.5	34.9	34.4	33.4	32.4	31.4	30.5	29.6	28.8	28.0	27.2	26.2	
3	36.8	36.8	36.0	35.2	34.5	33.8	32.5	31.3	30.2	29.1	28.2	27.2	26.4	25.6	24.5	
4	36.5	36.5	35.6	34.8	34.0	33.2	31.8	30.4	29.2	28.1	27.1	26.1	25.2	24.4	23.2	
5	36.3	36.3	35.3	34.4	33.5	32.7	31.1	29.7	28.4	27.2	26.2	25.2	24.2	-	-	
10	36.3	35.5	34.2	33.0	31.9	30.8	28.9	27.3	-	-	-	-	-	-	-	
15	36.3	35.0	33.4	32.1	30.8	29.6	-	-	-	-	-	-	-	-	-	
30	36.0	33.8	31.9	-	-	-	-	-	-	-	-	-	-	-	-	
1	37.0	37.0	36.3	35.5	34.9	34.4	33.4	32.4	31.4	30.5	29.6	28.7	28.0	27.2	26.2	10
2	36.5	36.5	35.6	34.8	33.9	33.2	31.7	30.4	29.2	28.1	27.0	26.0	25.1	24.3	23.1	
3	36.3	36.1	35.0	34.0	33.1	32.2	30.5	29.0	27.7	26.5	25.3	24.3	23.3	22.5	21.2	
4	36.3	35.8	34.6	33.4	32.4	31.4	29.6	28.0	26.5	25.2	24.1	23.0	22.0	21.1	19.9	
5	36.3	35.5	34.2	32.9	31.8	30.7	28.8	27.1	25.6	24.3	23.1	22.0	21.0	-	-	
10	36.3	34.4	32.7	31.1	29.7	28.4	26.2	24.2	-	-	-	-	-	-	-	
15	35.9	33.6	31.6	29.9	28.3	26.9	-	-	-	-	-	-	-	-	-	
30	35.0	32.1	29.6	-	-	-	-	-	-	-	-	-	-	-	-	
1	36.5	36.5	35.6	34.8	33.9	33.2	31.7	30.4	29.2	28.0	27.0	26.0	25.1	24.3	23.1	20
2	36.3	35.8	34.6	33.4	32.4	31.4	29.6	28.0	26.5	25.2	24.0	23.0	22.0	21.1	19.9	
3	36.3	35.2	33.8	32.5	31.3	30.1	28.1	26.4	24.8	23.4	22.2	21.1	20.1	19.1	17.9	
4	36.3	34.8	33.2	31.7	30.4	29.2	27.0	25.1	23.5	22.1	20.8	19.7	18.7	17.8	16.6	
5	36.3	34.4	32.6	31.1	29.7	28.4	26.1	24.2	22.5	21.0	19.8	18.6	17.6	-	-	
10	35.5	32.9	30.7	28.8	27.1	25.6	23.1	21.0	-	-	-	-	-	-	-	
15	34.9	31.9	29.4	27.3	25.5	23.9	-	-	-	-	-	-	-	-	-	
30	33.6	29.9	26.9	-	-	-	-	-	-	-	-	-	-	-	-	
1	36.3	35.8	34.6	33.4	32.4	31.4	29.6	28.0	26.5	23.2	20.3	18.0	16.2	14.7	13.0	40
2	36.3	34.8	33.2	31.7	30.4	29.2	27.0	25.1	23.5	21.6	18.9	16.8	15.1	13.8	12.1	
3	36.1	34.0	32.2	30.5	29.0	27.7	25.3	23.3	21.6	20.1	18.5	16.4	14.8	13.4	11.8	
4	35.8	33.4	31.4	29.6	28.0	26.5	24.0	22.0	20.2	18.8	17.5	16.2	14.6	13.3	11.7	
5	35.5	32.9	30.7	28.8	27.1	25.6	23.0	20.9	19.2	17.7	16.4	15.3	14.4	-	-	
10	34.4	31.1	28.4	26.1	24.2	22.5	19.8	17.6	-	-	-	-	-	-	-	
15	33.6	29.8	26.8	24.4	22.3	20.6	-	-	-	-	-	-	-	-	-	
30	31.9	27.3	23.9	-	-	-	-	-	-	-	-	-	-	-	-	
1	36.3	35.2	33.8	32.5	31.3	30.1	28.1	23.1	19.2	16.5	14.4	12.8	11.5	10.5	9.2	60
2	36.1	34.0	32.2	30.5	29.0	27.7	25.3	20.9	17.4	14.9	13.1	11.6	10.5	9.5	8.4	
3	35.6	33.2	31.0	29.2	27.5	26.0	23.5	20.2	16.8	14.4	12.6	11.2	10.1	9.2	8.1	
4	35.2	32.5	30.1	28.1	26.4	24.8	22.2	19.8	16.5	14.2	12.4	11.0	9.9	9.0	7.9	
5	34.9	31.9	29.4	27.3	25.4	23.8	21.1	19.0	16.3	14.0	12.2	10.9	9.8	-	-	
10	33.6	29.8	26.8	24.3	22.3	20.6	17.8	15.7	-	-	-	-	-	-	-	
15	32.6	28.4	25.1	22.5	20.4	18.6	-	-	-	-	-	-	-	-	-	
30	30.7	25.6	22.0	-	-	-	-	-	-	-	-	-	-	-	-	
1	36.3	34.8	33.2	31.7	30.4	29.2	23.0	18.4	15.3	13.1	11.5	10.2	9.2	8.4	7.4	80
2	35.8	33.4	31.4	29.6	28.0	26.5	20.3	16.2	13.5	11.6	10.1	9.0	8.1	7.4	6.5	
3	35.2	32.5	30.1	28.1	26.3	24.8	19.4	15.5	12.9	11.1	9.7	8.6	7.7	7.0	6.2	
4	34.8	31.7	29.2	27.0	25.1	23.5	18.9	15.1	12.6	10.8	9.5	8.4	7.6	6.9	6.1	
5	34.4	31.1	28.4	26.1	24.1	22.5	18.6	14.9	12.4	10.7	9.3	8.3	7.5	-	-	
10	32.9	28.8	25.6	23.0	20.9	19.2	16.4	14.4	-	-	-	-	-	-	-	
15	31.9	27.3	23.8	21.1	19.0	17.2	-	-	-	-	-	-	-	-	-	
30	29.8	24.4	20.6	-	-	-	-	-	-	-	-	-	-	-	-	
1	36.3	34.4	32.6	31.1	29.7	26.0	19.5	15.6	13.0	11.1	9.7	8.7	7.8	7.1	6.2	100
2	35.5	32.9	30.7	28.8	26.8	22.4	16.8	13.4	11.2	9.6	8.4	7.5	6.7	6.1	5.4	
3	34.9	31.9	29.4	27.3	25.4	21.1	15.9	12.7	10.6	9.1	7.9	7.0	6.3	5.8	5.1	
4	34.4	31.1	28.4	26.1	24.1	20.5	15.4	12.3	10.3	8.8	7.7	6.8	6.2	5.6	4.9	
5	33.9	30.4	27.5	25.1	23.1	20.2	15.1	12.1	10.1	8.6	7.6	6.7	6.1	-	-	
10	32.4	28.0	24.6	22.0	19.9	18.1	14.6	11.7	-	-	-	-	-	-	-	
15	31.3	26.4	22.8	20.1	17.9	16.2	-	-	-	-	-	-	-	-	-	
30	29.0	23.3	19.5	-	-	-	-	-	-	-	-	-	-	-	-	
1	35.8	33.6	31.6	29.6	23.7	19.7	14.8	11.8	9.9	8.5	7.4	6.6	5.9	5.4	4.7	150
2	34.9	31.9	29.4	24.2	19.3	16.1	12.1	9.7	8.1	6.9	6.0	5.4	4.8	4.4	3.9	
3	34.1	30.7	27.9	22.4	17.9	14.9	11.2	8.9	7.5	6.4	5.6	5.0	4.5	4.1	3.6	
4	33.6	29.8	26.8	21.4	17.2	14.3	10.7	8.6	7.1	6.1	5.4	4.8	4.3	3.9	3.4	
5	33.1	29.0	25.9	20.9	16.7	13.9	10.5	8.4	7.0	6.0	5.2	4.6	4.2	-	-	
10	31.3	26.4	22.8	19.8	15.8	13.2	9.9	7.9	-	-	-	-	-	-	-	
15	30.0	24.6	20.9	18.1	15.6	13.0	-	-	-	-	-	-	-	-	-	
30	27.5	21.4	17.6	-	-	-	-	-	-	-	-	-	-	-	-	
1	34.9	31.9	27.0	20.3	16.2	13.5	10.1	8.1	6.8	5.8	5.1	4.5	4.1	3.7	3.2	300
2	33.6	29.6	19.7	14.8	11.8	9.9	7.4	5.9	4.9	4.2	3.7	3.3	3.0	2.7	2.4	
3	32.6	26.0	17.3	13.0	10.4	8.7	6.5	5.2	4.3	3.7	3.2	2.9	2.6	2.4	2.1	
4	31.9	24.2	16.1	12.1	9.7	8.1	6.0	4.8	4.0	3.5	3.0	2.7	2.4	2.2	1.9	
5	31.3	23.1	15.4	11.5	9.2	7.7	5.8	4.6	3.8	3.3	2.9	2.6	2.3	-	-	
10	29.0	20.9	13.9	10.5	8.4	7.0	5.2	4.2	-	-	-	-	-	-	-	
15	27.5	20.2	13.4	10.1	8.1	6.7	-	-	-	-	-	-	-	-	-	
30	24.6	18.1	13.0	-	-	-	-	-	-	-	-	-	-	-	-	



Abaco per carichi in serie - Serial load rating - Abaque de charges successives

■ 1.0 - 3 ~ - 3000 min⁻¹

Potenza ammessa sul tubo in kW, per serie di n esposizioni, con frequenza z e durata di ogni esposizione in sec																
Anode input power as a function of n (N° of exposures in series), z (exp. rate per sec), the exposure time (sec)																
Puissance anodique en fonction de n (N° d'exp. de la séries), z (cadence d'exp. par sec), temps d'exposition (sec)																
z	0.010	0.020	0.030	0.040	0.050	0.060	0.080	0.100	0.120	0.140	0.160	0.180	0.200	0.220	0.250	n
1	21.4	21.4	20.9	20.5	20.2	19.9	19.5	19.2	18.9	18.7	18.5	18.2	17.9	17.6	17.1	5
2	21.3	21.3	20.9	20.5	20.2	19.9	19.5	18.9	18.4	18.0	17.5	17.1	16.7	16.3	15.7	
3	21.1	21.1	20.7	20.4	20.0	19.6	19.0	18.4	17.8	17.3	16.7	16.3	15.8	15.4	14.8	
4	21.0	21.0	20.6	20.1	19.7	19.3	18.6	17.9	17.3	16.7	16.2	15.6	15.2	14.7	14.1	
5	20.9	20.9	20.4	19.9	19.5	19.1	18.3	17.6	16.9	16.3	15.7	15.1	14.6	-	-	
10	20.9	20.5	19.9	19.2	18.7	18.1	17.2	16.3	-	-	-	-	-	-	-	
15	20.9	20.2	19.5	18.8	18.1	17.5	-	-	-	-	-	-	-	-	-	
30	20.7	19.7	18.7	-	-	-	-	-	-	-	-	-	-	-	-	
1	21.3	21.3	20.9	20.5	20.2	19.9	19.5	18.9	18.4	17.9	17.5	17.1	16.6	16.3	15.7	10
2	21.0	21.0	20.5	20.1	19.7	19.3	18.6	17.9	17.3	16.7	16.1	15.6	15.1	14.7	14.0	
3	20.9	20.8	20.3	19.8	19.3	18.8	18.0	17.2	16.5	15.8	15.2	14.7	14.2	13.7	13.0	
4	20.9	20.6	20.0	19.5	18.9	18.4	17.5	16.7	15.9	15.2	14.6	14.0	13.4	12.9	12.2	
5	20.9	20.5	19.8	19.2	18.6	18.1	17.1	16.2	15.4	14.7	14.0	13.4	12.8	-	-	
10	20.9	19.9	19.1	18.3	17.6	16.9	15.7	14.6	-	-	-	-	-	-	-	
15	20.7	19.6	18.6	17.6	16.8	16.1	-	-	-	-	-	-	-	-	-	
30	20.2	18.8	17.5	-	-	-	-	-	-	-	-	-	-	-	-	
1	21.0	21.0	20.5	20.1	19.7	19.3	18.6	17.9	17.3	16.7	16.1	15.6	15.1	14.7	14.0	20
2	20.9	20.6	20.0	19.5	18.9	18.4	17.5	16.6	15.9	15.2	14.5	14.0	13.4	12.9	12.2	
3	20.9	20.3	19.6	19.0	18.4	17.8	16.7	15.8	15.0	14.2	13.5	12.9	12.3	11.8	11.1	
4	20.9	20.1	19.3	18.6	17.9	17.3	16.1	15.1	14.3	13.5	12.8	12.1	11.6	11.0	10.3	
5	20.9	19.9	19.1	18.3	17.5	16.9	15.7	14.6	13.7	12.9	12.2	11.5	10.9	-	-	
10	20.5	19.2	18.1	17.1	16.2	15.4	14.0	12.8	-	-	-	-	-	-	-	
15	20.2	18.7	17.4	16.3	15.3	14.4	-	-	-	-	-	-	-	-	-	
30	19.6	17.6	16.1	-	-	-	-	-	-	-	-	-	-	-	-	
1	20.9	20.6	20.0	19.5	18.9	18.4	17.5	16.6	15.9	15.2	14.5	13.9	13.4	12.9	12.2	40
2	20.9	20.1	19.3	18.6	17.9	17.3	16.1	15.1	14.2	13.5	12.8	12.1	11.5	11.0	10.3	
3	20.8	19.8	18.8	18.0	17.2	16.5	15.2	14.1	13.2	12.4	11.7	11.0	10.4	9.9	9.2	
4	20.6	19.5	18.4	17.5	16.6	15.9	14.5	13.4	12.4	11.6	10.9	10.2	9.7	9.1	8.5	
5	20.5	19.2	18.1	17.1	16.2	15.4	14.0	12.8	11.8	11.0	10.3	9.6	9.1	-	-	
10	19.9	18.3	16.9	15.7	14.6	13.7	12.2	10.9	-	-	-	-	-	-	-	
15	19.5	17.6	16.0	14.7	13.6	12.6	-	-	-	-	-	-	-	-	-	
30	18.7	16.3	14.4	-	-	-	-	-	-	-	-	-	-	-	-	
1	20.9	20.3	19.6	19.0	18.4	17.8	16.7	15.8	14.9	14.2	13.5	12.8	11.5	10.5	9.2	60
2	20.8	19.8	18.8	18.0	17.2	16.5	15.2	14.1	13.2	12.4	11.7	11.0	10.4	9.5	8.4	
3	20.5	19.3	18.2	17.3	16.4	15.6	14.2	13.1	12.1	11.3	10.6	9.9	9.3	8.8	8.1	
4	20.3	19.0	17.8	16.7	15.8	14.9	13.5	12.3	11.3	10.5	9.8	9.1	8.6	8.1	7.4	
5	20.2	18.7	17.4	16.3	15.3	14.4	12.9	11.7	10.7	9.9	9.2	8.5	8.0	-	-	
10	19.5	17.6	16.0	14.7	13.6	12.6	11.1	9.8	-	-	-	-	-	-	-	
15	19.1	16.9	15.1	13.7	12.5	11.5	-	-	-	-	-	-	-	-	-	
30	18.1	15.4	13.4	-	-	-	-	-	-	-	-	-	-	-	-	
1	20.9	20.1	19.3	18.6	17.9	17.3	16.1	15.1	14.2	13.1	11.5	10.2	9.2	8.4	7.4	80
2	20.6	19.5	18.4	17.5	16.6	15.9	14.5	13.4	12.4	11.6	10.1	9.0	8.1	7.4	6.5	
3	20.3	19.0	17.8	16.7	15.8	14.9	13.5	12.3	11.3	10.5	9.7	8.6	7.7	7.0	6.2	
4	20.1	18.6	17.3	16.1	15.1	14.2	12.8	11.5	10.6	9.7	9.0	8.4	7.6	6.9	6.1	
5	19.9	18.3	16.9	15.6	14.6	13.7	12.2	10.9	9.9	9.1	8.4	7.8	7.3	-	-	
10	19.2	17.1	15.4	14.0	12.8	11.8	10.3	9.1	-	-	-	-	-	-	-	
15	18.7	16.3	14.4	12.9	11.7	10.7	-	-	-	-	-	-	-	-	-	
30	17.6	14.7	12.6	-	-	-	-	-	-	-	-	-	-	-	-	
1	20.9	19.9	19.1	18.3	17.5	16.8	15.6	14.6	13.0	11.1	9.7	8.7	7.8	7.1	6.2	100
2	20.5	19.2	18.1	17.1	16.2	15.4	14.0	12.8	11.2	9.6	8.4	7.5	6.7	6.1	5.4	
3	20.2	18.7	17.4	16.3	15.3	14.4	12.9	11.7	10.6	9.1	7.9	7.0	6.3	5.8	5.1	
4	19.9	18.3	16.9	15.6	14.6	13.7	12.2	10.9	9.9	8.8	7.7	6.8	6.2	5.6	4.9	
5	19.7	17.9	16.4	15.1	14.0	13.1	11.5	10.3	9.3	8.5	7.6	6.7	6.1	-	-	
10	18.9	16.6	14.9	13.4	12.2	11.2	9.7	8.5	-	-	-	-	-	-	-	
15	18.4	15.8	13.9	12.3	11.1	10.1	-	-	-	-	-	-	-	-	-	
30	17.2	14.2	12.0	-	-	-	-	-	-	-	-	-	-	-	-	
1	20.7	19.5	18.5	17.6	16.8	16.0	14.7	11.8	9.9	8.5	7.4	6.6	5.9	5.4	4.7	150
2	20.2	18.7	17.4	16.3	15.3	14.4	12.1	9.7	8.1	6.9	6.0	5.4	4.8	4.4	3.9	
3	19.8	18.1	16.6	15.4	14.3	13.4	11.2	8.9	7.5	6.4	5.6	5.0	4.5	4.1	3.6	
4	19.5	17.6	16.0	14.7	13.6	12.6	10.7	8.6	7.1	6.1	5.4	4.8	4.3	3.9	3.4	
5	19.3	17.2	15.5	14.1	13.0	12.0	10.4	8.4	7.0	6.0	5.2	4.6	4.2	-	-	
10	18.4	15.8	13.8	12.3	11.1	10.1	8.6	7.4	-	-	-	-	-	-	-	
15	17.7	14.9	12.8	11.2	10.0	9.0	-	-	-	-	-	-	-	-	-	
30	16.4	13.1	10.9	-	-	-	-	-	-	-	-	-	-	-	-	
1	20.2	18.7	17.4	16.3	15.3	13.5	10.1	8.1	6.8	5.8	5.1	4.5	4.1	3.7	3.2	300
2	19.5	17.6	16.0	14.7	11.8	9.9	7.4	5.9	4.9	4.2	3.7	3.3	3.0	2.7	2.4	
3	19.1	16.8	15.1	13.0	10.4	8.7	6.5	5.2	4.3	3.7	3.2	2.9	2.6	2.4	2.1	
4	18.7	16.3	14.4	12.1	9.7	8.1	6.0	4.8	4.0	3.5	3.0	2.7	2.4	2.2	1.9	
5	18.4	15.8	13.8	11.5	9.2	7.7	5.8	4.6	3.8	3.3	2.9	2.6	2.3	-	-	
10	17.2	14.1	12.0	10.4	8.4	7.0	5.2	4.2	-	-	-	-	-	-	-	
15	16.4	13.1	10.9	9.3	8.1	6.7	-	-	-	-	-	-	-	-	-	
30	14.9	11.2	9.0	-	-	-	-	-	-	-	-	-	-	-	-	



Abaco per carichi in serie - Serial load rating - Abaque de charges successives

■ 2.0 - 3 ~ - 3000 min⁻¹

Potenza ammessa sul tubo in kW, per serie di n esposizioni, con frequenza z e durata di ogni esposizione in sec																
Anode input power as a function of n (N° of exposures in series), z (exp. rate per sec), the exposure time (sec)																
Puissance anodique en fonction de n (N° d'exp. de la série), z (cadence d'exp. par sec), temps d'exposition (sec)																
z	0.010	0.020	0.030	0.040	0.050	0.060	0.080	0.100	0.120	0.140	0.160	0.180	0.200	0.220	0.250	n
1	44.7	44.7	43.1	41.9	41.1	40.4	39.3	38.4	37.7	37.0	36.4	35.9	35.0	34.2	33.0	5
2	44.1	44.1	43.1	41.9	41.1	40.4	39.1	37.7	36.4	35.1	34.0	32.9	31.9	30.9	29.6	
3	43.7	43.7	42.6	41.6	40.6	39.6	37.8	36.2	34.7	33.3	32.1	30.9	29.8	28.8	27.4	
4	43.4	43.4	42.1	41.0	39.8	38.8	36.8	35.1	33.5	32.0	30.7	29.4	28.3	27.2	25.8	
5	43.1	43.1	41.7	40.4	39.2	38.1	36.0	34.1	32.4	30.9	29.5	28.2	27.1	-	-	
10	43.1	42.0	40.2	38.5	37.0	35.6	33.1	30.9	-	-	-	-	-	-	-	
15	43.1	41.2	39.1	37.2	35.5	34.0	-	-	-	-	-	-	-	-	-	
30	42.6	39.6	37.0	-	-	-	-	-	-	-	-	-	-	-	-	
1	44.1	44.1	43.1	41.9	41.1	40.4	39.1	37.7	36.3	35.1	33.9	32.8	31.8	30.9	29.5	10
2	43.4	43.4	42.1	40.9	39.8	38.7	36.8	35.0	33.4	31.9	30.6	29.4	28.2	27.2	25.7	
3	43.1	42.8	41.3	39.9	38.6	37.4	35.2	33.2	31.5	29.9	28.5	27.2	26.0	24.9	23.4	
4	43.1	42.3	40.7	39.1	37.7	36.4	34.0	31.9	30.0	28.3	26.9	25.5	24.3	23.2	21.8	
5	43.1	41.9	40.1	38.4	36.9	35.5	32.9	30.7	28.8	27.1	25.6	24.3	23.1	-	-	
10	43.1	40.4	38.1	36.0	34.1	32.4	29.5	27.1	-	-	-	-	-	-	-	
15	42.5	39.4	36.7	34.3	32.3	30.5	-	-	-	-	-	-	-	-	-	
30	41.2	37.2	34.0	-	-	-	-	-	-	-	-	-	-	-	-	
1	43.4	43.4	42.1	40.9	39.8	38.7	36.8	35.0	33.4	31.9	30.6	29.3	28.2	27.1	24.2	20
2	43.1	42.3	40.6	39.1	37.7	36.3	33.9	31.8	30.0	28.3	26.8	25.5	24.3	23.2	21.7	
3	43.1	41.6	39.6	37.8	36.2	34.7	32.0	29.8	27.8	26.1	24.5	23.2	22.0	20.9	19.4	
4	43.1	40.9	38.7	36.8	35.0	33.4	30.6	28.2	26.2	24.4	22.9	21.5	20.3	19.2	17.8	
5	43.1	40.4	38.0	35.9	34.0	32.4	29.4	27.0	24.9	23.1	21.6	20.3	19.1	-	-	
10	41.9	38.4	35.5	32.9	30.7	28.8	25.6	23.1	-	-	-	-	-	-	-	
15	41.1	37.1	33.7	31.0	28.6	26.6	-	-	-	-	-	-	-	-	-	
30	39.4	34.3	30.5	-	-	-	-	-	-	-	-	-	-	-	-	
1	43.1	42.3	40.6	39.1	37.7	36.3	33.9	31.8	27.0	23.2	20.3	18.0	16.2	14.7	13.0	40
2	43.1	40.9	38.7	36.8	35.0	33.4	30.6	28.2	25.2	21.6	18.9	16.8	15.1	13.8	12.1	
3	42.8	39.9	37.4	35.2	33.2	31.4	28.4	25.9	23.9	21.1	18.5	16.4	14.8	13.4	11.8	
4	42.3	39.1	36.3	33.9	31.8	30.0	26.8	24.3	22.2	20.4	18.2	16.2	14.6	13.3	11.7	
5	41.9	38.4	35.4	32.9	30.7	28.8	25.6	23.0	20.9	19.2	17.7	16.1	14.5	-	-	
10	40.4	35.9	32.4	29.4	27.0	24.9	21.6	19.1	-	-	-	-	-	-	-	
15	39.3	34.2	30.3	27.2	24.7	22.6	-	-	-	-	-	-	-	-	-	
30	37.1	31.0	26.6	-	-	-	-	-	-	-	-	-	-	-	-	
1	43.1	41.5	39.6	37.8	36.2	34.7	28.8	23.1	19.2	16.5	14.4	12.8	11.5	10.5	9.2	60
2	42.8	39.9	37.4	35.2	33.2	31.4	26.1	20.9	17.4	14.9	13.1	11.6	10.5	9.5	8.4	
3	42.1	38.7	35.9	33.4	31.2	29.3	25.2	20.2	16.8	14.4	12.6	11.2	10.1	9.2	8.1	
4	41.5	37.8	34.7	32.0	29.8	27.8	24.5	19.8	16.5	14.2	12.4	11.0	9.9	9.0	7.9	
5	41.1	37.0	33.7	30.9	28.6	26.5	23.2	19.6	16.3	14.0	12.2	10.9	9.8	-	-	
10	39.3	34.2	30.3	27.2	24.7	22.6	19.3	16.8	-	-	-	-	-	-	-	
15	38.0	32.4	28.2	24.9	22.3	20.3	-	-	-	-	-	-	-	-	-	
30	35.5	28.8	24.3	-	-	-	-	-	-	-	-	-	-	-	-	
1	43.1	40.9	38.7	36.8	35.0	30.7	23.0	18.4	15.3	13.1	11.5	10.2	9.2	8.4	7.4	80
2	42.3	39.1	36.3	33.9	31.8	27.0	20.3	16.2	13.5	11.6	10.1	9.0	8.1	7.4	6.5	
3	41.5	37.8	34.7	32.0	29.7	25.8	19.4	15.5	12.9	11.1	9.7	8.6	7.7	7.0	6.2	
4	40.9	36.8	33.4	30.6	28.2	25.2	18.9	15.1	12.6	10.8	9.5	8.4	7.6	6.9	6.1	
5	40.4	35.9	32.3	29.4	27.0	24.9	18.6	14.9	12.4	10.7	9.3	8.3	7.5	-	-	
10	38.4	32.9	28.8	25.6	23.0	20.9	17.7	14.5	-	-	-	-	-	-	-	
15	37.0	30.9	26.5	23.3	20.7	18.6	-	-	-	-	-	-	-	-	-	
30	34.2	27.2	22.6	-	-	-	-	-	-	-	-	-	-	-	-	
1	43.1	40.4	38.0	35.9	31.2	26.0	19.5	15.6	13.0	11.1	9.7	8.7	7.8	7.1	6.2	100
2	41.9	38.4	35.4	32.9	26.8	22.4	16.8	13.4	11.2	9.6	8.4	7.5	6.7	6.1	5.4	
3	41.1	37.0	33.7	30.9	25.4	21.1	15.9	12.7	10.6	9.1	7.9	7.0	6.3	5.8	5.1	
4	40.4	35.9	32.3	29.4	24.6	20.5	15.4	12.3	10.3	8.8	7.7	6.8	6.2	5.6	4.9	
5	39.8	35.0	31.2	28.2	24.2	20.2	15.1	12.1	10.1	8.6	7.6	6.7	6.1	-	-	
10	37.7	31.8	27.6	24.3	21.7	19.4	14.6	11.7	-	-	-	-	-	-	-	
15	36.2	29.8	25.3	22.0	19.4	17.4	-	-	-	-	-	-	-	-	-	
30	33.2	26.0	21.3	-	-	-	-	-	-	-	-	-	-	-	-	
1	42.4	39.3	36.6	29.6	23.7	19.7	14.8	11.8	9.9	8.5	7.4	6.6	5.9	5.4	4.7	150
2	41.1	37.0	32.2	24.2	19.3	16.1	12.1	9.7	8.1	6.9	6.0	5.4	4.8	4.4	3.9	
3	40.1	35.4	29.8	22.4	17.9	14.9	11.2	8.9	7.5	6.4	5.6	5.0	4.5	4.1	3.6	
4	39.3	34.2	28.6	21.4	17.2	14.3	10.7	8.6	7.1	6.1	5.4	4.8	4.3	3.9	3.4	
5	38.6	33.2	27.9	20.9	16.7	13.9	10.5	8.4	7.0	6.0	5.2	4.6	4.2	-	-	
10	36.2	29.8	25.3	19.8	15.8	13.2	9.9	7.9	-	-	-	-	-	-	-	
15	34.5	27.6	22.9	19.4	15.6	13.0	-	-	-	-	-	-	-	-	-	
30	31.2	23.6	19.0	-	-	-	-	-	-	-	-	-	-	-	-	
1	41.1	37.0	27.0	20.3	16.2	13.5	10.1	8.1	6.8	5.8	5.1	4.5	4.1	3.7	3.2	300
2	39.3	29.6	19.7	14.8	11.8	9.9	7.4	5.9	4.9	4.2	3.7	3.3	3.0	2.7	2.4	
3	38.0	26.0	17.3	13.0	10.4	8.7	6.5	5.2	4.3	3.7	3.2	2.9	2.6	2.4	2.1	
4	37.0	24.2	16.1	12.1	9.7	8.1	6.0	4.8	4.0	3.5	3.0	2.7	2.4	2.2	1.9	
5	36.2	23.1	15.4	11.5	9.2	7.7	5.8	4.6	3.8	3.3	2.9	2.6	2.3	-	-	
10	33.2	20.9	13.9	10.5	8.4	7.0	5.2	4.2	-	-	-	-	-	-	-	
15	31.2	20.2	13.4	10.1	8.1	6.7	-	-	-	-	-	-	-	-	-	
30	27.6	19.4	13.0	-	-	-	-	-	-	-	-	-	-	-	-	



Abaco per carichi in serie - Serial load rating - Abaque de charges successives

▣ **1.0 - 1 ~ - 10000 min⁻¹**

Potenza ammessa sul tubo in kW, per serie di n esposizioni, con frequenza z e durata di ogni esposizione in sec Anode input power as a function of n (N° of exposures in series), z (exp. rate per sec), the exposure time (sec) Puissance anodique en fonction de n (N° d'exp. de la séries), z (cadence d'exp. par sec), temps d'exposition (sec)																
z	0.010	0.020	0.030	0.040	0.050	0.060	0.080	0.100	0.120	0.140	0.160	0.180	0.200	0.220	0.250	n
1	35.0	33.7	32.8	32.2	31.7	31.2	30.4	29.8	29.2	28.7	28.3	27.8	27.4	26.7	25.7	5
2	35.0	33.7	32.8	32.2	31.7	31.2	30.4	29.6	28.5	27.4	26.5	25.6	24.8	24.0	22.9	
3	35.0	33.7	32.8	32.2	31.7	31.2	29.7	28.4	27.1	26.0	24.9	24.0	23.1	22.3	21.1	
4	35.0	33.7	32.8	32.2	31.4	30.5	28.9	27.4	26.1	24.9	23.8	22.8	21.8	21.0	19.8	
5	35.0	33.7	32.8	31.9	30.9	29.9	28.1	26.6	25.2	24.0	22.8	21.8	20.8	-	-	
10	34.9	33.2	31.6	30.2	29.0	27.8	25.7	23.9	-	-	-	-	-	-	-	
15	34.5	32.5	30.7	29.1	27.7	26.4	-	-	-	-	-	-	-	-	-	
30	33.6	31.0	28.8	-	-	-	-	-	-	-	-	-	-	-	-	
1	35.0	33.7	32.8	32.2	31.7	31.2	30.4	29.6	28.5	27.4	26.5	25.6	24.8	24.0	22.9	10
2	35.0	33.7	32.8	32.2	31.4	30.5	28.8	27.4	26.0	24.8	23.7	22.7	21.8	21.0	19.8	
3	35.0	33.7	32.6	31.5	30.4	29.4	27.5	25.9	24.5	23.2	22.0	21.0	20.0	19.1	18.0	
4	35.0	33.5	32.1	30.8	29.6	28.5	26.5	24.8	23.3	21.9	20.7	19.6	18.7	17.8	16.6	
5	34.9	33.2	31.6	30.2	28.9	27.7	25.7	23.9	22.3	20.9	19.7	18.6	17.7	-	-	
10	34.1	31.9	29.9	28.1	26.6	25.2	22.8	20.8	-	-	-	-	-	-	-	
15	33.6	31.0	28.7	26.8	25.1	23.6	-	-	-	-	-	-	-	-	-	
30	32.5	29.1	26.4	-	-	-	-	-	-	-	-	-	-	-	-	
1	35.0	33.7	32.8	32.2	31.4	30.5	28.8	27.4	26.0	24.8	23.7	22.7	21.8	21.0	19.8	20
2	35.0	33.5	32.1	30.8	29.6	28.5	26.5	24.8	23.2	21.9	20.7	19.6	18.7	17.8	16.6	
3	34.7	32.8	31.2	29.7	28.3	27.1	24.9	23.1	21.5	20.1	18.9	17.8	16.8	16.0	14.8	
4	34.4	32.3	30.5	28.8	27.4	26.0	23.7	21.8	20.2	18.8	17.5	16.5	15.5	14.7	13.6	
5	34.1	31.9	29.9	28.1	26.6	25.2	22.8	20.8	19.2	17.7	16.5	15.5	14.5	-	-	
10	33.2	30.2	27.7	25.7	23.9	22.3	19.7	17.7	-	-	-	-	-	-	-	
15	32.4	29.1	26.3	24.0	22.1	20.5	-	-	-	-	-	-	-	-	-	
30	31.0	26.8	23.6	-	-	-	-	-	-	-	-	-	-	-	-	
1	35.0	33.5	32.1	30.8	29.6	28.5	26.5	24.8	23.2	21.9	20.3	18.0	16.2	14.7	13.0	40
2	34.4	32.3	30.5	28.8	27.4	26.0	23.7	21.8	20.2	18.8	17.5	16.5	15.1	13.8	12.1	
3	33.9	31.5	29.4	27.5	25.9	24.4	22.0	20.0	18.3	16.9	15.7	14.6	13.7	12.9	11.8	
4	33.5	30.8	28.5	26.5	24.8	23.2	20.7	18.7	17.0	15.6	14.4	13.4	12.5	11.7	10.7	
5	33.1	30.2	27.7	25.6	23.8	22.3	19.7	17.7	16.0	14.6	13.5	12.5	11.6	-	-	
10	31.9	28.1	25.2	22.8	20.8	19.2	16.5	14.5	-	-	-	-	-	-	-	
15	30.9	26.7	23.5	21.0	19.0	17.3	-	-	-	-	-	-	-	-	-	
30	29.1	24.0	20.5	-	-	-	-	-	-	-	-	-	-	-	-	
1	34.7	32.8	31.2	29.7	28.3	27.1	24.9	23.1	19.2	16.5	14.4	12.8	11.5	10.5	9.2	60
2	33.9	31.5	29.4	27.5	25.9	24.4	22.0	20.0	17.4	14.9	13.1	11.6	10.5	9.5	8.4	
3	33.3	30.5	28.1	26.0	24.3	22.7	20.2	18.1	16.5	14.4	12.6	11.2	10.1	9.2	8.1	
4	32.8	29.7	27.1	24.9	23.1	21.5	18.9	16.8	15.2	13.8	12.4	11.0	9.9	9.0	7.9	
5	32.4	29.0	26.3	24.0	22.1	20.5	17.8	15.8	14.2	12.9	11.8	10.9	9.8	-	-	
10	30.9	26.7	23.5	21.0	19.0	17.3	14.7	12.8	-	-	-	-	-	-	-	
15	29.9	25.2	21.8	19.2	17.1	15.5	-	-	-	-	-	-	-	-	-	
30	27.7	22.3	18.6	-	-	-	-	-	-	-	-	-	-	-	-	
1	34.4	32.3	30.5	28.8	27.4	26.0	23.0	18.4	15.3	13.1	11.5	10.2	9.2	8.4	7.4	80
2	33.5	30.8	28.5	26.5	24.8	23.2	20.3	16.2	13.5	11.6	10.1	9.0	8.1	7.4	6.5	
3	32.8	29.7	27.1	24.9	23.1	21.5	18.9	15.5	12.9	11.1	9.7	8.6	7.7	7.0	6.2	
4	32.3	28.8	26.0	23.7	21.8	20.2	17.5	15.1	12.6	10.8	9.5	8.4	7.6	6.9	6.1	
5	31.9	28.1	25.2	22.8	20.8	19.2	16.5	14.5	12.4	10.7	9.3	8.3	7.5	-	-	
10	30.2	25.6	22.3	19.7	17.7	16.0	13.5	11.6	-	-	-	-	-	-	-	
15	29.0	24.0	20.5	17.8	15.8	14.2	-	-	-	-	-	-	-	-	-	
30	26.7	21.0	17.3	-	-	-	-	-	-	-	-	-	-	-	-	
1	34.1	31.9	29.9	28.1	26.6	25.2	19.5	15.6	13.0	11.1	9.7	8.7	7.8	7.1	6.2	100
2	33.1	30.2	27.7	25.6	23.8	22.3	16.8	13.4	11.2	9.6	8.4	7.5	6.7	6.1	5.4	
3	32.4	29.0	26.3	24.0	22.1	20.5	15.9	12.7	10.6	9.1	7.9	7.0	6.3	5.8	5.1	
4	31.9	28.1	25.2	22.8	20.8	19.2	15.4	12.3	10.3	8.8	7.7	6.8	6.2	5.6	4.9	
5	31.4	27.4	24.3	21.8	19.8	18.1	15.1	12.1	10.1	8.6	7.6	6.7	6.1	-	-	
10	29.6	24.8	21.3	18.7	16.6	15.0	12.5	10.7	-	-	-	-	-	-	-	
15	28.3	23.1	19.5	16.8	14.8	13.2	-	-	-	-	-	-	-	-	-	
30	25.9	20.0	16.3	-	-	-	-	-	-	-	-	-	-	-	-	
1	33.6	30.9	28.7	26.7	23.7	19.7	14.8	11.8	9.9	8.5	7.4	6.6	5.9	5.4	4.7	150
2	32.4	29.0	26.3	24.0	19.3	16.1	12.1	9.7	8.1	6.9	6.0	5.4	4.8	4.4	3.9	
3	31.6	27.7	24.7	22.3	17.9	14.9	11.2	8.9	7.5	6.4	5.6	5.0	4.5	4.1	3.6	
4	30.9	26.7	23.5	21.0	17.2	14.3	10.7	8.6	7.1	6.1	5.4	4.8	4.3	3.9	3.4	
5	30.4	25.9	22.6	20.0	16.7	13.9	10.5	8.4	7.0	6.0	5.2	4.6	4.2	-	-	
10	28.3	23.1	19.5	16.8	14.8	13.2	9.9	7.9	-	-	-	-	-	-	-	
15	27.0	21.3	17.6	15.0	13.1	11.6	-	-	-	-	-	-	-	-	-	
30	24.3	18.1	14.5	-	-	-	-	-	-	-	-	-	-	-	-	
1	32.4	29.0	26.3	20.3	16.2	13.5	10.1	8.1	6.8	5.8	5.1	4.5	4.1	3.7	3.2	300
2	30.9	26.7	19.7	14.8	11.8	9.9	7.4	5.9	4.9	4.2	3.7	3.3	3.0	2.7	2.4	
3	29.9	25.2	17.3	13.0	10.4	8.7	6.5	5.2	4.3	3.7	3.2	2.9	2.6	2.4	2.1	
4	29.0	24.0	16.1	12.1	9.7	8.1	6.0	4.8	4.0	3.5	3.0	2.7	2.4	2.2	1.9	
5	28.3	23.1	15.4	11.5	9.2	7.7	5.8	4.6	3.8	3.3	2.9	2.6	2.3	-	-	
10	25.9	20.0	13.9	10.5	8.4	7.0	5.2	4.2	-	-	-	-	-	-	-	
15	24.3	18.1	13.4	10.1	8.1	6.7	-	-	-	-	-	-	-	-	-	
30	21.3	15.0	11.6	-	-	-	-	-	-	-	-	-	-	-	-	



Abaco per carichi in serie - Serial load rating - Abaque de charges successives

■ 2.0 - 1 ~ - 10000 min⁻¹

Potenza ammessa sul tubo in kW, per serie di n esposizioni, con frequenza z e durata di ogni esposizione in sec																
Anode input power as a function of n (N° of exposures in series), z (exp. rate per sec), the exposure time (sec)																
Puissance anodique en fonction de n (N° d'exp. de la série), z (cadence d'exp. par sec), temps d'exposition (sec)																
z	0.010	0.020	0.030	0.040	0.050	0.060	0.080	0.100	0.120	0.140	0.160	0.180	0.200	0.220	0.250	n
1	74.1	70.2	67.8	66.0	64.6	63.3	61.2	59.5	58.0	56.7	55.6	54.6	53.4	51.7	49.4	5
2	74.1	70.2	67.8	66.0	64.6	63.3	61.2	59.0	56.2	53.6	51.2	49.1	47.1	45.2	42.7	
3	74.1	70.2	67.8	66.0	64.6	63.3	59.4	55.9	52.7	50.0	47.5	45.2	43.1	41.3	38.7	
4	74.1	70.2	67.8	66.0	63.8	61.4	57.2	53.4	50.2	47.3	44.7	42.4	40.3	38.4	35.9	
5	74.1	70.2	67.8	65.2	62.4	59.9	55.3	51.5	48.1	45.1	42.5	40.2	38.1	-	-	
10	73.6	68.8	64.5	60.7	57.4	54.4	49.3	45.0	-	-	-	-	-	-	-	
15	72.5	66.8	62.0	57.8	54.1	50.9	-	-	-	-	-	-	-	-	-	
30	70.1	62.9	57.0	-	-	-	-	-	-	-	-	-	-	-	-	
1	74.1	70.2	67.8	66.0	64.6	63.3	61.2	59.0	56.2	53.6	51.2	49.0	47.0	45.2	42.7	10
2	74.1	70.2	67.8	66.0	63.8	61.4	57.1	53.4	50.1	47.2	44.7	42.4	40.3	38.4	35.9	
3	74.1	70.2	67.3	64.1	61.1	58.5	53.8	49.8	46.3	43.3	40.7	38.4	36.3	34.4	31.9	
4	74.1	69.7	65.7	62.2	59.0	56.2	51.2	47.1	43.5	40.5	37.8	35.5	33.5	31.6	29.3	
5	73.6	68.7	64.4	60.7	57.3	54.3	49.2	44.9	41.3	38.3	35.7	33.4	31.3	-	-	
10	71.5	65.2	59.9	55.3	51.5	48.1	42.5	38.1	-	-	-	-	-	-	-	
15	70.0	62.7	56.8	51.9	47.7	44.2	-	-	-	-	-	-	-	-	-	
30	66.8	57.8	50.9	-	-	-	-	-	-	-	-	-	-	-	-	
1	74.1	70.2	67.8	66.0	63.8	61.4	57.1	53.4	50.1	43.2	37.8	33.6	30.3	27.5	24.2	20
2	74.1	69.7	65.7	62.2	59.0	56.2	51.2	47.0	43.5	40.5	36.5	32.4	29.2	26.5	23.2	
3	73.1	67.9	63.3	59.3	55.8	52.7	47.4	43.1	39.5	36.5	33.9	31.6	28.8	26.2	23.0	
4	72.2	66.4	61.4	57.1	53.4	50.1	44.7	40.3	36.7	33.7	31.1	28.9	27.0	25.3	22.9	
5	71.5	65.1	59.8	55.3	51.4	48.1	42.5	38.1	34.5	31.5	29.0	26.9	25.1	-	-	
10	68.7	60.7	54.3	49.2	44.9	41.3	35.7	31.3	-	-	-	-	-	-	-	
15	66.7	57.7	50.8	45.3	40.9	37.3	-	-	-	-	-	-	-	-	-	
30	62.7	51.9	44.2	-	-	-	-	-	-	-	-	-	-	-	-	
1	74.1	69.7	65.7	62.2	59.0	54.1	40.6	32.4	27.0	23.2	20.3	18.0	16.2	14.7	13.0	40
2	72.2	66.4	61.4	57.1	53.4	50.1	37.8	30.3	25.2	21.6	18.9	16.8	15.1	13.8	12.1	
3	70.8	64.0	58.4	53.7	49.8	46.3	36.9	29.5	24.6	21.1	18.5	16.4	14.8	13.4	11.8	
4	69.7	62.2	56.2	51.2	47.0	43.5	36.5	29.2	24.3	20.8	18.2	16.2	14.6	13.3	11.7	
5	68.7	60.7	54.3	49.2	44.9	41.3	35.6	29.0	24.1	20.7	18.1	16.1	14.5	-	-	
10	65.1	55.3	48.1	42.5	38.1	34.5	29.0	25.1	-	-	-	-	-	-	-	
15	62.6	51.8	44.2	38.5	34.1	30.6	-	-	-	-	-	-	-	-	-	
30	57.7	45.3	37.3	-	-	-	-	-	-	-	-	-	-	-	-	
1	73.1	67.8	63.3	57.7	46.2	38.5	28.8	23.1	19.2	16.5	14.4	12.8	11.5	10.5	9.2	60
2	70.8	64.0	58.4	52.3	41.8	34.8	26.1	20.9	17.4	14.9	13.1	11.6	10.5	9.5	8.4	
3	69.2	61.4	55.2	50.1	40.3	33.6	25.2	20.2	16.8	14.4	12.6	11.2	10.1	9.2	8.1	
4	67.8	59.3	52.7	47.4	39.6	33.0	24.8	19.8	16.5	14.2	12.4	11.0	9.9	9.0	7.9	
5	66.7	57.6	50.7	45.3	39.2	32.7	24.5	19.6	16.3	14.0	12.2	10.9	9.8	-	-	
10	62.6	51.8	44.1	38.5	34.1	30.6	23.9	19.2	-	-	-	-	-	-	-	
15	59.8	48.1	40.2	34.5	30.2	26.9	-	-	-	-	-	-	-	-	-	
30	54.3	41.3	33.4	-	-	-	-	-	-	-	-	-	-	-	-	
1	72.2	66.4	61.3	46.0	36.8	30.7	23.0	18.4	15.3	13.1	11.5	10.2	9.2	8.4	7.4	80
2	69.7	62.2	54.1	40.6	32.4	27.0	20.3	16.2	13.5	11.6	10.1	9.0	8.1	7.4	6.5	
3	67.8	59.3	51.6	38.7	31.0	25.8	19.4	15.5	12.9	11.1	9.7	8.6	7.7	7.0	6.2	
4	66.4	57.1	50.1	37.8	30.3	25.2	18.9	15.1	12.6	10.8	9.5	8.4	7.6	6.9	6.1	
5	65.1	55.3	48.0	37.3	29.8	24.9	18.6	14.9	12.4	10.7	9.3	8.3	7.5	-	-	
10	60.7	49.2	41.3	35.6	29.0	24.1	18.1	14.5	-	-	-	-	-	-	-	
15	57.6	45.3	37.3	31.7	27.6	23.9	-	-	-	-	-	-	-	-	-	
30	51.8	38.5	30.6	-	-	-	-	-	-	-	-	-	-	-	-	
1	71.5	65.1	52.0	39.0	31.2	26.0	19.5	15.6	13.0	11.1	9.7	8.7	7.8	7.1	6.2	100
2	68.7	60.7	44.7	33.5	26.8	22.4	16.8	13.4	11.2	9.6	8.4	7.5	6.7	6.1	5.4	
3	66.7	57.6	42.3	31.7	25.4	21.1	15.9	12.7	10.6	9.1	7.9	7.0	6.3	5.8	5.1	
4	65.1	55.3	41.1	30.8	24.6	20.5	15.4	12.3	10.3	8.8	7.7	6.8	6.2	5.6	4.9	
5	63.8	53.4	40.3	30.3	24.2	20.2	15.1	12.1	10.1	8.6	7.6	6.7	6.1	-	-	
10	59.0	47.0	38.9	29.2	23.3	19.4	14.6	11.7	-	-	-	-	-	-	-	
15	55.8	43.1	35.1	28.8	23.0	19.2	-	-	-	-	-	-	-	-	-	
30	49.8	36.3	28.5	-	-	-	-	-	-	-	-	-	-	-	-	
1	69.9	59.2	39.5	29.6	23.7	19.7	14.8	11.8	9.9	8.5	7.4	6.6	5.9	5.4	4.7	150
2	66.7	48.3	32.2	24.2	19.3	16.1	12.1	9.7	8.1	6.9	6.0	5.4	4.8	4.4	3.9	
3	64.4	44.7	29.8	22.4	17.9	14.9	11.2	8.9	7.5	6.4	5.6	5.0	4.5	4.1	3.6	
4	62.6	42.9	28.6	21.4	17.2	14.3	10.7	8.6	7.1	6.1	5.4	4.8	4.3	3.9	3.4	
5	61.1	41.8	27.9	20.9	16.7	13.9	10.5	8.4	7.0	6.0	5.2	4.6	4.2	-	-	
10	55.8	39.6	26.4	19.8	15.8	13.2	9.9	7.9	-	-	-	-	-	-	-	
15	52.4	38.9	25.9	19.4	15.6	13.0	-	-	-	-	-	-	-	-	-	
30	45.9	32.3	24.9	-	-	-	-	-	-	-	-	-	-	-	-	
1	66.7	40.5	27.0	20.3	16.2	13.5	10.1	8.1	6.8	5.8	5.1	4.5	4.1	3.7	3.2	300
2	59.2	29.6	19.7	14.8	11.8	9.9	7.4	5.9	4.9	4.2	3.7	3.3	3.0	2.7	2.4	
3	52.0	26.0	17.3	13.0	10.4	8.7	6.5	5.2	4.3	3.7	3.2	2.9	2.6	2.4	2.1	
4	48.3	24.2	16.1	12.1	9.7	8.1	6.0	4.8	4.0	3.5	3.0	2.7	2.4	2.2	1.9	
5	46.2	23.1	15.4	11.5	9.2	7.7	5.8	4.6	3.8	3.3	2.9	2.6	2.3	-	-	
10	41.8	20.9	13.9	10.5	8.4	7.0	5.2	4.2	-	-	-	-	-	-	-	
15	40.3	20.2	13.4	10.1	8.1	6.7	-	-	-	-	-	-	-	-	-	
30	38.9	19.4	13.0	-	-	-	-	-	-	-	-	-	-	-	-	



Abaco per carichi in serie - Serial load rating - Abaque de charges successives

▣ **1.0 - 3 ~ - 10000 min⁻¹**

Potenza ammessa sul tubo in kW, per serie di n esposizioni, con frequenza z e durata di ogni esposizione in sec																
Anode input power as a function of n (N° of exposures in series), z (exp. rate per sec), the exposure time (sec)																
Puissance anodique en fonction de n (N° d'exp. de la série), z (cadence d'exp. par sec), temps d'exposition (sec)																
z	0.010	0.020	0.030	0.040	0.050	0.060	0.080	0.100	0.120	0.140	0.160	0.180	0.200	0.220	0.250	n
1	41.7	39.8	38.6	37.7	37.0	36.3	35.3	34.4	33.7	33.0	32.4	31.9	31.3	30.4	29.1	5
2	41.7	39.8	38.6	37.7	37.0	36.3	35.3	34.2	32.7	31.4	30.1	29.0	27.9	26.9	25.6	
3	41.7	39.8	38.6	37.7	37.0	36.3	34.3	32.5	30.9	29.5	28.1	26.9	25.8	24.8	23.4	
4	41.7	39.8	38.6	37.7	36.6	35.4	33.2	31.3	29.6	28.0	26.6	25.4	24.2	23.2	21.8	
5	41.7	39.8	38.6	37.3	35.9	34.6	32.3	30.2	28.5	26.9	25.5	24.2	23.0	-	-	
10	41.4	39.0	36.9	35.0	33.3	31.8	29.1	26.8	-	-	-	-	-	-	-	
15	40.9	38.1	35.7	33.5	31.6	29.9	-	-	-	-	-	-	-	-	-	
30	39.7	36.1	33.1	-	-	-	-	-	-	-	-	-	-	-	-	
1	41.7	39.8	38.6	37.7	37.0	36.3	35.3	34.2	32.7	31.3	30.1	29.0	27.9	26.9	25.5	10
2	41.7	39.8	38.6	37.7	36.6	35.4	33.2	31.3	29.5	28.0	26.6	25.4	24.2	23.2	21.8	
3	41.7	39.8	38.3	36.7	35.2	33.9	31.4	29.3	27.5	25.9	24.4	23.2	22.0	20.9	19.5	
4	41.7	39.5	37.5	35.8	34.2	32.7	30.1	27.9	26.0	24.3	22.9	21.6	20.4	19.4	18.0	
5	41.4	39.0	36.9	35.0	33.3	31.7	29.0	26.7	24.8	23.1	21.6	20.3	19.2	-	-	
10	40.4	37.3	34.6	32.3	30.2	28.5	25.5	23.0	-	-	-	-	-	-	-	
15	39.6	36.0	33.0	30.5	28.3	26.4	-	-	-	-	-	-	-	-	-	
30	38.1	33.5	29.9	-	-	-	-	-	-	-	-	-	-	-	-	
1	41.7	39.8	38.6	37.7	36.6	35.4	33.2	31.3	29.5	28.0	26.6	25.4	24.2	23.2	21.8	20
2	41.7	39.5	37.5	35.8	34.2	32.7	30.1	27.9	26.0	24.3	22.9	21.6	20.4	19.4	18.0	
3	41.2	38.6	36.3	34.3	32.5	30.9	28.1	25.8	23.8	22.1	20.6	19.3	18.2	17.2	15.9	
4	40.7	37.9	35.4	33.2	31.3	29.5	26.6	24.2	22.2	20.5	19.1	17.8	16.7	15.7	14.4	
5	40.4	37.2	34.6	32.2	30.2	28.4	25.4	23.0	21.0	19.3	17.9	16.6	15.6	-	-	
10	39.0	35.0	31.7	29.0	26.7	24.8	21.6	19.2	-	-	-	-	-	-	-	
15	38.0	33.5	29.9	27.0	24.6	22.6	-	-	-	-	-	-	-	-	-	
30	36.0	30.5	26.4	-	-	-	-	-	-	-	-	-	-	-	-	
1	41.7	39.5	37.5	35.8	34.2	32.7	30.1	27.9	26.0	23.2	20.3	18.0	16.2	14.7	13.0	40
2	40.7	37.9	35.4	33.2	31.3	29.5	26.6	24.2	22.2	20.5	18.9	16.8	15.1	13.8	12.1	
3	40.1	36.7	33.9	31.4	29.3	27.5	24.4	22.0	20.0	18.3	16.9	15.7	14.6	13.4	11.8	
4	39.5	35.8	32.7	30.1	27.9	26.0	22.9	20.4	18.4	16.8	15.4	14.3	13.3	12.4	11.3	
5	39.0	35.0	31.7	29.0	26.7	24.8	21.6	19.2	17.2	15.7	14.3	13.2	12.3	-	-	
10	37.2	32.2	28.4	25.4	23.0	21.0	17.9	15.6	-	-	-	-	-	-	-	
15	36.0	30.4	26.3	23.2	20.8	18.8	-	-	-	-	-	-	-	-	-	
30	33.5	27.0	22.6	-	-	-	-	-	-	-	-	-	-	-	-	
1	41.2	38.6	36.3	34.3	32.5	30.9	28.1	23.1	19.2	16.5	14.4	12.8	11.5	10.5	9.2	60
2	40.1	36.7	33.9	31.4	29.3	27.5	24.4	20.9	17.4	14.9	13.1	11.6	10.5	9.5	8.4	
3	39.2	35.4	32.2	29.5	27.3	25.4	22.2	19.8	16.8	14.4	12.6	11.2	10.1	9.2	8.1	
4	38.6	34.3	30.9	28.1	25.8	23.8	20.6	18.2	16.3	14.2	12.4	11.0	9.9	9.0	7.9	
5	38.0	33.4	29.8	26.9	24.6	22.6	19.4	17.0	15.2	13.7	12.2	10.9	9.8	-	-	
10	36.0	30.4	26.3	23.2	20.8	18.8	15.8	13.6	-	-	-	-	-	-	-	
15	34.6	28.4	24.1	21.0	18.6	16.6	-	-	-	-	-	-	-	-	-	
30	31.7	24.8	20.3	-	-	-	-	-	-	-	-	-	-	-	-	
1	40.7	37.9	35.4	33.2	31.3	29.5	23.0	18.4	15.3	13.1	11.5	10.2	9.2	8.4	7.4	80
2	39.5	35.8	32.7	30.1	27.9	26.0	20.3	16.2	13.5	11.6	10.1	9.0	8.1	7.4	6.5	
3	38.6	34.3	30.9	28.1	25.8	23.8	19.4	15.5	12.9	11.1	9.7	8.6	7.7	7.0	6.2	
4	37.9	33.2	29.5	26.6	24.2	22.2	18.9	15.1	12.6	10.8	9.5	8.4	7.6	6.9	6.1	
5	37.2	32.2	28.4	25.4	23.0	21.0	17.9	14.9	12.4	10.7	9.3	8.3	7.5	-	-	
10	35.0	29.0	24.8	21.6	19.2	17.2	14.3	12.3	-	-	-	-	-	-	-	
15	33.5	27.0	22.6	19.4	17.0	15.2	-	-	-	-	-	-	-	-	-	
30	30.4	23.2	18.8	-	-	-	-	-	-	-	-	-	-	-	-	
1	40.4	37.2	34.6	32.2	30.2	26.0	19.5	15.6	13.0	11.1	9.7	8.7	7.8	7.1	6.2	100
2	39.0	35.0	31.7	29.0	26.7	22.4	16.8	13.4	11.2	9.6	8.4	7.5	6.7	6.1	5.4	
3	38.0	33.4	29.8	26.9	24.6	21.1	15.9	12.7	10.6	9.1	7.9	7.0	6.3	5.8	5.1	
4	37.2	32.2	28.4	25.4	23.0	20.5	15.4	12.3	10.3	8.8	7.7	6.8	6.2	5.6	4.9	
5	36.6	31.3	27.3	24.2	21.8	19.8	15.1	12.1	10.1	8.6	7.6	6.7	6.1	-	-	
10	34.2	27.9	23.6	20.4	18.0	16.1	13.3	11.3	-	-	-	-	-	-	-	
15	32.5	25.8	21.3	18.2	15.9	14.1	-	-	-	-	-	-	-	-	-	
30	29.3	22.0	17.6	-	-	-	-	-	-	-	-	-	-	-	-	
1	39.6	36.0	33.0	29.6	23.7	19.7	14.8	11.8	9.9	8.5	7.4	6.6	5.9	5.4	4.7	150
2	38.0	33.4	29.8	24.2	19.3	16.1	12.1	9.7	8.1	6.9	6.0	5.4	4.8	4.4	3.9	
3	36.9	31.7	27.8	22.4	17.9	14.9	11.2	8.9	7.5	6.4	5.6	5.0	4.5	4.1	3.6	
4	36.0	30.4	26.3	21.4	17.2	14.3	10.7	8.6	7.1	6.1	5.4	4.8	4.3	3.9	3.4	
5	35.2	29.3	25.1	20.9	16.7	13.9	10.5	8.4	7.0	6.0	5.2	4.6	4.2	-	-	
10	32.5	25.8	21.3	18.2	15.8	13.2	9.9	7.9	-	-	-	-	-	-	-	
15	30.7	23.6	19.1	16.1	13.9	12.2	-	-	-	-	-	-	-	-	-	
30	27.3	19.8	15.5	-	-	-	-	-	-	-	-	-	-	-	-	
1	38.0	33.4	27.0	20.3	16.2	13.5	10.1	8.1	6.8	5.8	5.1	4.5	4.1	3.7	3.2	300
2	36.0	29.6	19.7	14.8	11.8	9.9	7.4	5.9	4.9	4.2	3.7	3.3	3.0	2.7	2.4	
3	34.6	26.0	17.3	13.0	10.4	8.7	6.5	5.2	4.3	3.7	3.2	2.9	2.6	2.4	2.1	
4	33.4	24.2	16.1	12.1	9.7	8.1	6.0	4.8	4.0	3.5	3.0	2.7	2.4	2.2	1.9	
5	32.5	23.1	15.4	11.5	9.2	7.7	5.8	4.6	3.8	3.3	2.9	2.6	2.3	-	-	
10	29.3	20.9	13.9	10.5	8.4	7.0	5.2	4.2	-	-	-	-	-	-	-	
15	27.3	19.8	13.4	10.1	8.1	6.7	-	-	-	-	-	-	-	-	-	
30	23.6	16.1	12.2	-	-	-	-	-	-	-	-	-	-	-	-	



Abaco per carichi in serie - Serial load rating - Abaque de charges successives

■ **2.0 - 3 ~ - 10000 min⁻¹**

Potenza ammessa sul tubo in kW, per serie di n esposizioni, con frequenza z e durata di ogni esposizione in sec																
Anode input power as a function of n (N° of exposures in series), z (exp. rate per sec), the exposure time (sec)																
Puissance anodique en fonction de n (N° d'expos. de la série), z (cadence d'exp. par sec), temps d'exposition (sec)																
z	0.010	0.020	0.030	0.040	0.050	0.060	0.080	0.100	0.120	0.140	0.160	0.180	0.200	0.220	0.250	n
1	87.8	82.4	79.1	76.7	74.7	73.0	70.3	68.0	66.1	64.4	63.0	61.7	60.2	58.0	55.1	5
2	87.8	82.4	79.1	76.7	74.7	73.0	70.3	67.4	63.7	60.4	57.4	54.7	52.2	50.0	46.9	
3	87.8	82.4	79.1	76.7	74.7	73.0	67.8	63.3	59.3	55.8	52.7	49.9	47.4	45.2	42.2	
4	87.8	82.4	79.1	76.7	73.7	70.5	65.0	60.2	56.1	52.5	49.3	46.5	44.0	41.8	38.8	
5	87.8	82.4	79.1	75.5	71.8	68.5	62.6	57.7	53.5	49.9	46.7	43.9	41.4	-	-	
10	87.1	80.4	74.6	69.6	65.3	61.4	55.0	49.7	-	-	-	-	-	-	-	
15	85.5	77.7	71.3	65.8	61.1	57.0	-	-	-	-	-	-	-	-	-	
30	82.2	72.4	64.7	-	-	-	-	-	-	-	-	-	-	-	-	
1	87.8	82.4	79.1	76.7	74.7	73.0	70.3	67.4	63.7	60.4	57.4	54.7	52.2	50.0	46.7	10
2	87.8	82.4	79.1	76.7	73.7	70.5	64.9	60.2	56.0	52.5	49.3	46.5	44.0	41.8	38.8	
3	87.8	82.4	78.4	74.0	70.1	66.7	60.6	55.6	51.3	47.7	44.5	41.7	39.3	37.1	34.2	
4	87.8	81.7	76.3	71.6	67.4	63.7	57.4	52.2	47.9	44.3	41.1	38.4	36.0	33.9	31.2	
5	87.1	80.3	74.6	69.6	65.2	61.3	54.8	49.6	45.3	41.6	38.5	35.9	33.6	-	-	
10	84.2	75.5	68.5	62.6	57.7	53.5	46.7	41.4	-	-	-	-	-	-	-	
15	82.1	72.2	64.5	58.2	53.1	48.8	-	-	-	-	-	-	-	-	-	
30	77.7	65.8	57.0	-	-	-	-	-	-	-	-	-	-	-	-	
1	87.8	82.4	79.1	76.7	73.7	70.5	64.9	60.2	50.4	43.2	37.8	33.6	30.3	27.5	24.2	20
2	87.8	81.7	76.3	71.6	67.4	63.7	57.4	52.2	47.9	41.7	36.5	32.4	29.2	26.5	23.3	
3	86.4	79.2	73.0	67.8	63.3	59.3	52.7	47.4	43.1	39.5	36.0	32.0	28.8	26.2	23.0	
4	85.2	77.2	70.5	64.9	60.2	56.0	49.3	44.0	39.7	36.2	33.3	30.8	28.6	26.0	22.9	
5	84.1	75.5	68.4	62.6	57.7	53.5	46.7	41.4	37.2	33.8	30.9	28.5	26.5	-	-	
10	80.3	69.6	61.3	54.8	49.6	45.3	38.5	33.6	-	-	-	-	-	-	-	
15	77.6	65.6	56.8	50.1	44.8	40.5	-	-	-	-	-	-	-	-	-	
30	72.2	58.2	48.8	-	-	-	-	-	-	-	-	-	-	-	-	
1	87.8	81.7	76.3	71.6	64.9	54.1	40.6	32.4	27.0	23.2	20.3	18.0	16.2	14.7	13.0	40
2	85.2	77.1	70.5	64.9	60.2	50.4	37.8	30.3	25.2	21.6	18.9	16.8	15.1	13.8	12.1	
3	83.2	74.0	66.6	60.6	55.6	49.2	36.9	29.5	24.6	21.1	18.5	16.4	14.8	13.4	11.8	
4	81.7	71.6	63.7	57.4	52.2	47.9	36.5	29.2	24.3	20.8	18.2	16.2	14.6	13.3	11.7	
5	80.3	69.5	61.3	54.8	49.6	45.2	36.2	29.0	24.1	20.7	18.1	16.1	14.5	-	-	
10	75.5	62.6	53.5	46.7	41.4	37.2	30.9	26.5	-	-	-	-	-	-	-	
15	72.1	58.1	48.7	41.9	36.7	32.7	-	-	-	-	-	-	-	-	-	
30	65.6	50.1	40.5	-	-	-	-	-	-	-	-	-	-	-	-	
1	86.4	79.1	73.0	67.8	62.6	57.7	46.7	38.5	32.4	27.0	23.2	20.3	18.0	16.2	14.7	60
2	83.2	74.0	66.6	60.6	55.6	49.2	36.9	29.5	24.6	21.1	18.5	16.4	14.8	13.4	11.8	
3	81.0	70.5	62.4	50.4	40.3	33.6	25.2	20.2	16.8	14.4	12.6	11.2	10.1	9.2	8.1	
4	79.1	67.8	59.3	49.5	39.6	33.0	24.8	19.8	16.5	14.2	12.4	11.0	9.9	9.0	7.9	
5	77.6	65.6	56.8	49.0	39.2	32.7	24.5	19.6	16.3	14.0	12.2	10.9	9.8	-	-	
10	72.1	58.1	48.7	41.9	36.7	31.9	23.9	19.2	-	-	-	-	-	-	-	
15	68.4	53.5	43.9	37.2	32.3	28.5	-	-	-	-	-	-	-	-	-	
30	61.3	45.3	35.9	-	-	-	-	-	-	-	-	-	-	-	-	
1	85.2	77.1	61.3	46.0	36.8	30.7	23.0	18.4	15.3	13.1	11.5	10.2	9.2	8.4	7.4	80
2	81.7	71.6	54.1	40.6	32.4	27.0	20.3	16.2	13.5	11.6	10.1	9.0	8.1	7.4	6.5	
3	79.1	67.8	51.6	38.7	31.0	25.8	19.4	15.5	12.9	11.1	9.7	8.6	7.7	7.0	6.2	
4	77.1	64.9	50.4	37.8	30.3	25.2	18.9	15.1	12.6	10.8	9.5	8.4	7.6	6.9	6.1	
5	75.5	62.6	49.7	37.3	29.8	24.9	18.6	14.9	12.4	10.7	9.3	8.3	7.5	-	-	
10	69.5	54.8	45.2	36.2	29.0	24.1	18.1	14.5	-	-	-	-	-	-	-	
15	65.6	50.1	40.5	34.0	28.7	23.9	-	-	-	-	-	-	-	-	-	
30	58.1	41.9	32.7	-	-	-	-	-	-	-	-	-	-	-	-	
1	84.1	75.5	52.0	39.0	31.2	26.0	19.5	15.6	13.0	11.1	9.7	8.7	7.8	7.1	6.2	100
2	80.3	67.1	44.7	33.5	26.8	22.4	16.8	13.4	11.2	9.6	8.4	7.5	6.7	6.1	5.4	
3	77.6	63.4	42.3	31.7	25.4	21.1	15.9	12.7	10.6	9.1	7.9	7.0	6.3	5.8	5.1	
4	75.5	61.6	41.1	30.8	24.6	20.5	15.4	12.3	10.3	8.8	7.7	6.8	6.2	5.6	4.9	
5	73.7	60.2	40.3	30.3	24.2	20.2	15.1	12.1	10.1	8.6	7.6	6.7	6.1	-	-	
10	67.4	52.2	38.9	29.2	23.3	19.4	14.6	11.7	-	-	-	-	-	-	-	
15	63.3	47.4	37.9	28.8	23.0	19.2	-	-	-	-	-	-	-	-	-	
30	55.6	39.3	30.4	-	-	-	-	-	-	-	-	-	-	-	-	
1	82.0	59.2	39.5	29.6	23.7	19.7	14.8	11.8	9.9	8.5	7.4	6.6	5.9	5.4	4.7	150
2	77.6	48.3	32.2	24.2	19.3	16.1	12.1	9.7	8.1	6.9	6.0	5.4	4.8	4.4	3.9	
3	74.5	44.7	29.8	22.4	17.9	14.9	11.2	8.9	7.5	6.4	5.6	5.0	4.5	4.1	3.6	
4	72.1	42.9	28.6	21.4	17.2	14.3	10.7	8.6	7.1	6.1	5.4	4.8	4.3	3.9	3.4	
5	70.1	41.8	27.9	20.9	16.7	13.9	10.5	8.4	7.0	6.0	5.2	4.6	4.2	-	-	
10	63.3	39.6	26.4	19.8	15.8	13.2	9.9	7.9	-	-	-	-	-	-	-	
15	58.8	38.9	25.9	19.4	15.6	13.0	-	-	-	-	-	-	-	-	-	
30	50.8	34.7	25.4	-	-	-	-	-	-	-	-	-	-	-	-	
1	77.6	40.5	27.0	20.3	16.2	13.5	10.1	8.1	6.8	5.8	5.1	4.5	4.1	3.7	3.2	300
2	59.2	29.6	19.7	14.8	11.8	9.9	7.4	5.9	4.9	4.2	3.7	3.3	3.0	2.7	2.4	
3	52.0	26.0	17.3	13.0	10.4	8.7	6.5	5.2	4.3	3.7	3.2	2.9	2.6	2.4	2.1	
4	48.3	24.2	16.1	12.1	9.7	8.1	6.0	4.8	4.0	3.5	3.0	2.7	2.4	2.2	1.9	
5	46.2	23.1	15.4	11.5	9.2	7.7	5.8	4.6	3.8	3.3	2.9	2.6	2.3	-	-	
10	41.8	20.9	13.9	10.5	8.4	7.0	5.2	4.2	-	-	-	-	-	-	-	
15	40.3	20.2	13.4	10.1	8.1	6.7	-	-	-	-	-	-	-	-	-	
30	38.9	19.4	13.0	-	-	-	-	-	-	-	-	-	-	-	-	

Caratteristica di emissione del catodo
Cathode emission characteristic
Caractéristique d'émission de la cathode
 ■ 1.0 - 3 ~ - (± 0.2 A)

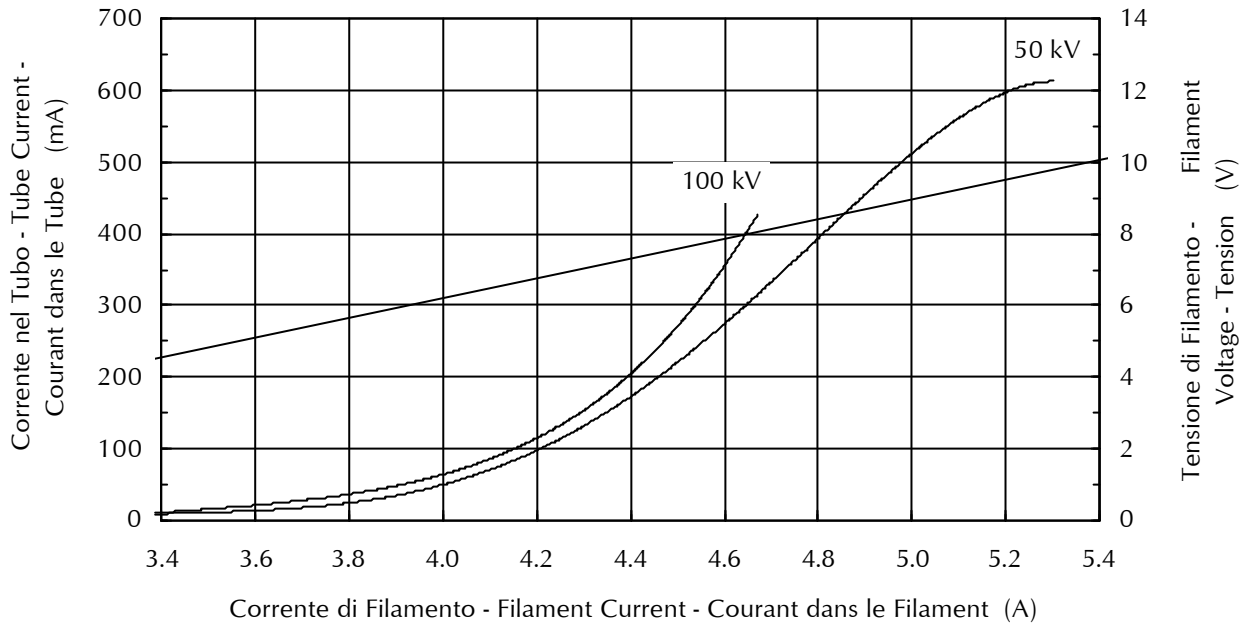

Caratteristica di emissione del catodo
Cathode emission characteristic
Caractéristique d'émission de la cathode
 ■ 2.0 - 3 ~ - (± 0.2 A)

