

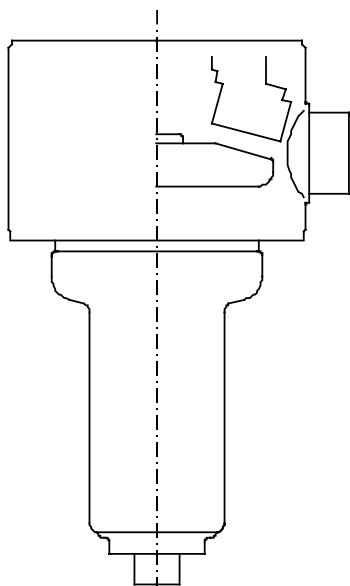

Documentazione Tubo a raggi X  
Tube Documentation  
Documentation du Tube

# XM65 T 0.1/0.3



Nr. di matricola  
Tube No.  
Nr de série

CE 0051

Questa documentazione deve essere fornita all'utilizzatore del complesso tubo-guaina  
The contents of this documentation must be transmitted to the user of the tube-assembly  
Le contenu de cette documentation doit être transmis à l'utilisateur de la gaine équipée







Documentazione N° Documentation N° N° de Documentation	Revisione Edition Version	Data di edizione Date of release Date de l'édition	Testo originale Original text Texte original
XM65TS13	0	17.09.2010	italiano / italian / italien



---

**Sommario - Table of contents - Table des matières**

---

Sommario - Table of contents - Table des matières .....	2
Caratteristiche - Specifications - Spécifications .....	3
Dimensioni - Dimension - Dimensions .....	4
Curva di raffreddamento dell'anodo Anode cooling curve Courbe de refroidissement de l'anode .....	5
Curve di riscaldamento dell'anodo Anode heating curves Courbes d'échauffement de l'anode.....	5
CURVE DI CARICO SINGOLO - SINGLE LOAD RATING - ABAQUE DE CHARGE UNIQUE  0.1 - 3 ~ - 3000 min <sup>-1</sup> .....	6
CURVE DI CARICO SINGOLO - SINGLE LOAD RATING - ABAQUE DE CHARGE UNIQUE  0.3 - 3 ~ - 3000 min <sup>-1</sup> .....	6
CURVE DI CARICO SINGOLO - SINGLE LOAD RATING - ABAQUE DE CHARGE UNIQUE  0.1 - 3 ~ - 10000 min <sup>-1</sup> .....	7
CURVE DI CARICO SINGOLO - SINGLE LOAD RATING - ABAQUE DE CHARGE UNIQUE  0.3 - 3 ~ - 10000 min <sup>-1</sup> .....	7
Caratteristica di emissione del catodo Cathode emission characteristic Caractéristique d'émission de la cathode  0.1 - 3 ~ - (± 0.2 A)8	
Caratteristica di emissione del catodo Cathode emission characteristic Caractéristique d'émission de la cathode  0.3 - 3 ~ - (± 0.2 A)8	

**Dichiarazione di conformità**

Questo prodotto soddisfa i requisiti essenziali della direttiva 93/42/CEE  
in accordo alle norme EN 60613 (IEC 613) e EN 60336 (IEC 336)

**Declaration of conformity**

This tube fulfils the essential requirements of the directive 93/42/EEC  
according to standard EN 60613 (IEC 613) and EN 60336 (IEC 336).

**Confirmation de conformité**

Ce tube remplit les exigences essentielles de la directive 93/42/CEE en  
accord avec les normes EN 60613 (IEC 613) et EN 60336 (IEC 336).



**Caratteristiche - Specifications - Spécifications**

Macchie focali e condizioni di misura Focal spots and measure conditions Foyers et conditions de mesure	<input type="checkbox"/> 0.1 <input checked="" type="checkbox"/> 0.3	25 kV 20 mA 25 kV 100 mA	(IEC 336, EN 60336)
Massima corrente di emissione Max emission current Max courant d'émission	<input type="checkbox"/> 0.1 <input checked="" type="checkbox"/> 0.3	35 mA 25 kV 140 mA 25 kV	
Angolo tra asse di riferimento e piano della pista focale Angle_between axis reference and focal spot plane Angle entre axe de référence et surface de la piste focale		10 °	
Velocità di rotazione dell'anodo Anode speed Vitesse de l'anode		3000 min <sup>-1</sup> 10000 min <sup>-1</sup>	
Potenza anodica nominale Nominal anode input power Puissance anodique nominale	<input type="checkbox"/> <input checked="" type="checkbox"/>	1.38 kW 2.5 kW 5.3 kW 8.9 kW	(IEC 613, EN 60613)
Diametro anodico Anode diameter Diamètre de l'anode		100 mm	
Materiale anodico Anode material Matériau de l'anode		RT-TZM-C	
Angolo anodico Anode angle Pente de l'anode		15 °	
Campo di radiazione con cuffia inclinata di 7.5° Radiation field with housing tilted at 7.5° Champ de rayonnement avec la gaine inclinée à 7.5°		18 cm a 50 cm	
Filtrazione inerente Inherent filtration Filtration inhérente		0.5 mm Be	
Capacità termica anodica Maximum anode heat content Chaleur maximale accumulée dans l'anode		450 kJ 600 kHU	
Dissipazione termica continua massima Maximum continuous heat dissipation Dissipation thermique continue maximale		1000 W	
Alta tensione nominale Nominal X-ray tube voltage Haute tension nominale		49 kV	

I dati forniti nella presente documentazione si intendono riferiti a:

The data indicated in this documentation refer to:

Les données indiquées dans cette documentation sont calculées pour:

Potenza anodica di equilibrio termico		% della capacità termica anodica	
Equivalent anode input power	100 W =	% of maximum anode heat content	33%
Puissance anodique d'équilibre thermique		% de chaleur max. accumulée dans l'anode	

**Dimensioni - Dimension - Dimensions**

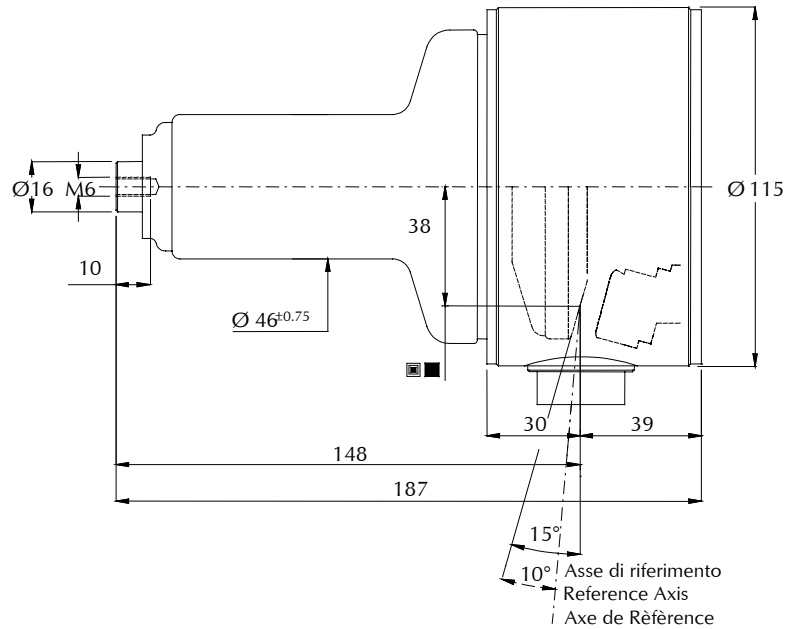

**Vista A - View A - Vue A**

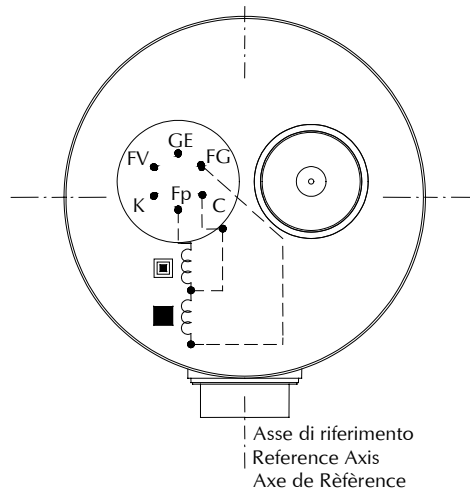

**Collegamenti - Connector - Connexions**

Fuoco piccolo	Small focal spot	Petit foyer	FP
Fuoco grande	Large focal spot	Grand foy	FG
Comune <i>Deve essere collegato a terra o direttamente o attraverso il circuito di misura dei mA</i>	Common <i>Must be connected to ground either directly or trough mA measurement circuit</i>	Commun <i>Doit être raccorder à la terre ou directement ou par le circuit de mesure des mA</i>	C
Utilizzati in fase di produzione	Used during working process	Utilisés pendant le procédé de production	K - FV - GE

**Curva di raffreddamento dell'anodo**  
**Anode cooling curve**  
**Courbe de refroidissement de l'anode**

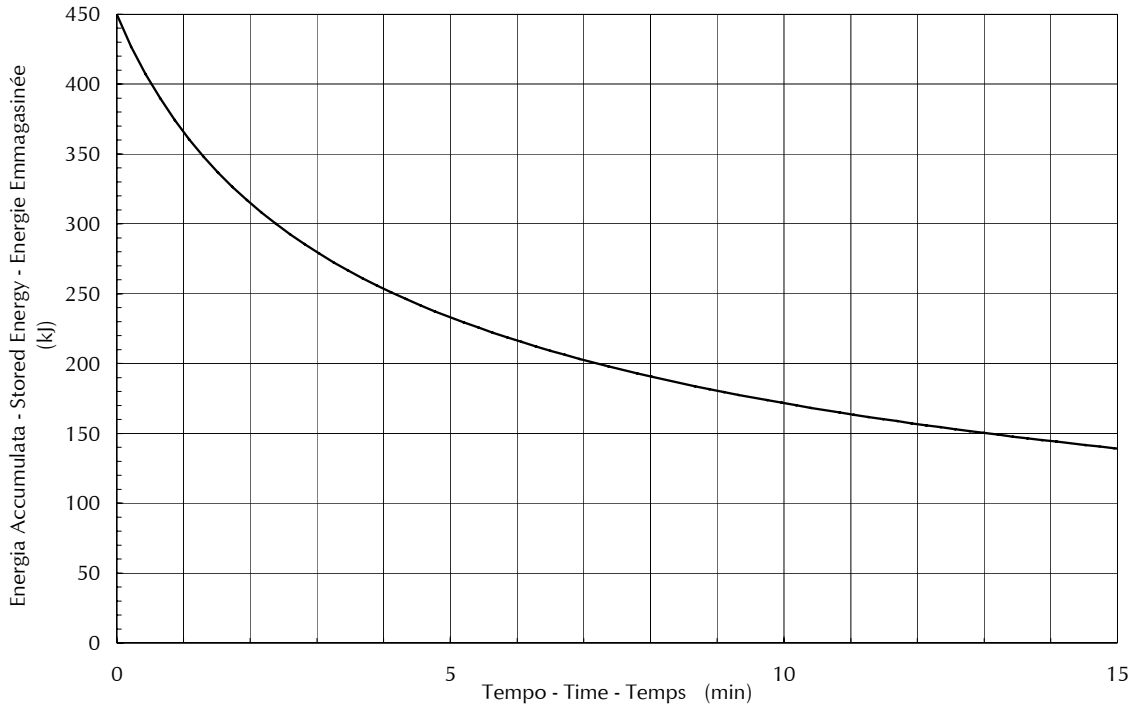

**Curve di riscaldamento dell'anodo**  
**Anode heating curves**  
**Courbes d'échauffement de l'anode**

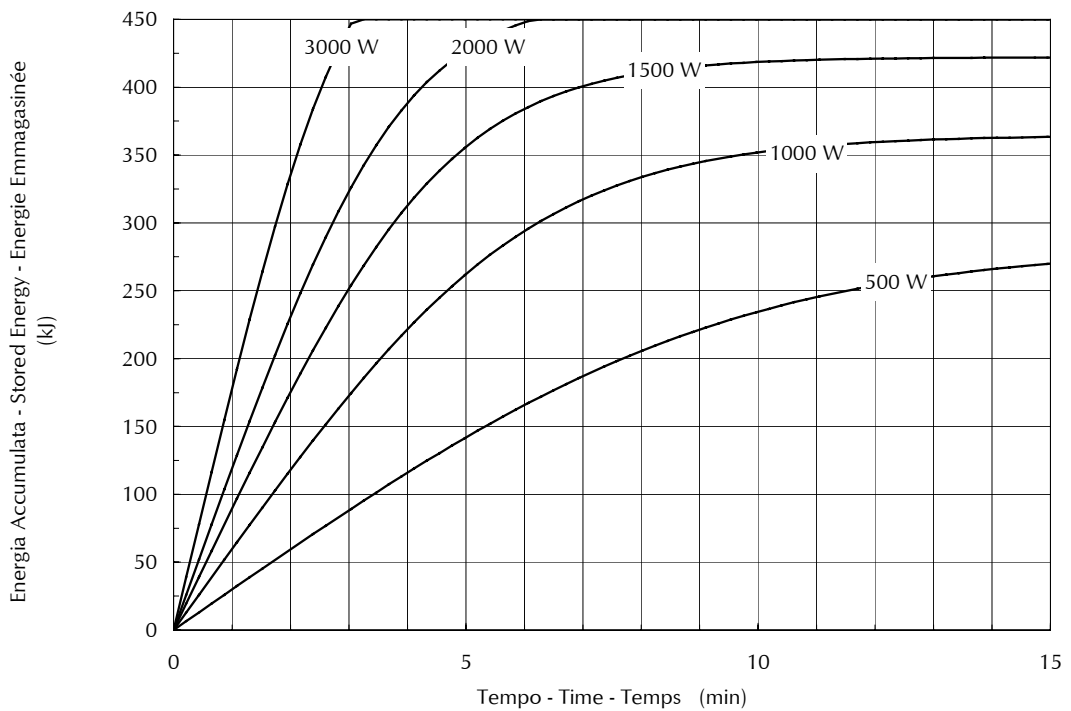



**CURVE DI CARICO SINGOLO - SINGLE LOAD RATING - ABAQUE DE CHARGE UNIQUE**

▣ 0.1 - 3 ~ - 3000 min<sup>-1</sup>

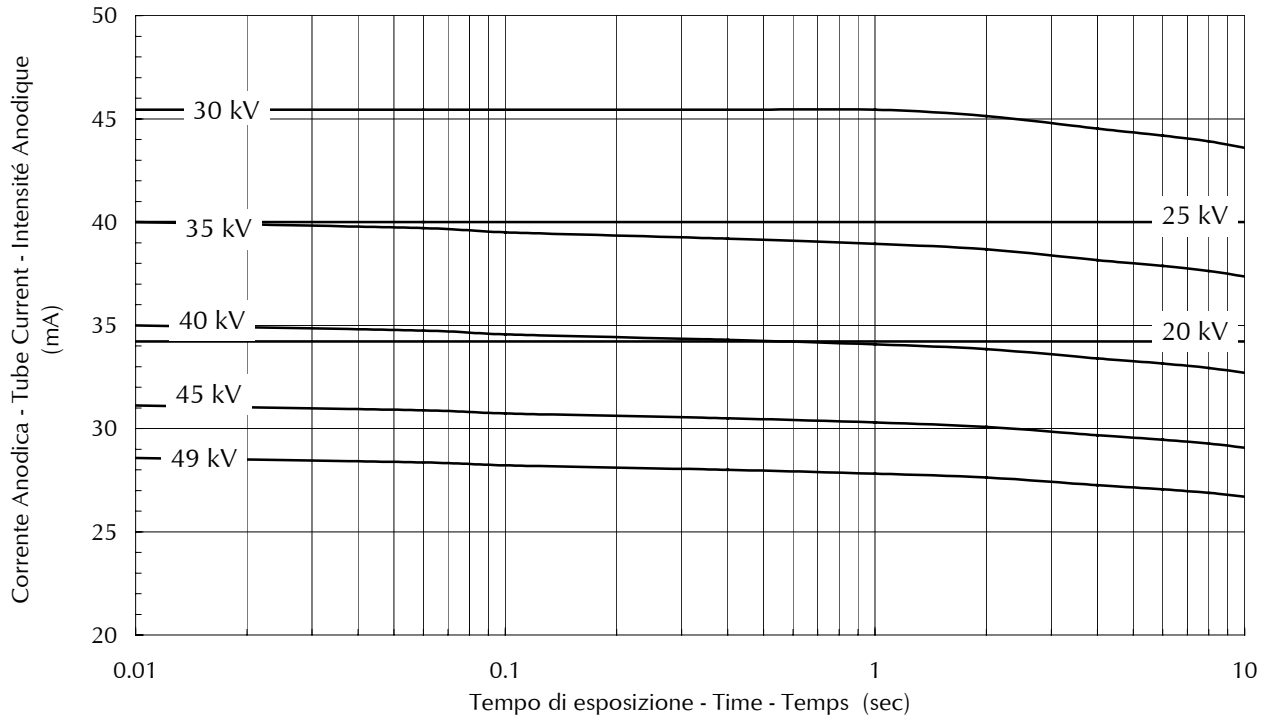

**CURVE DI CARICO SINGOLO - SINGLE LOAD RATING - ABAQUE DE CHARGE UNIQUE**

■ 0.3 - 3 ~ - 3000 min<sup>-1</sup>

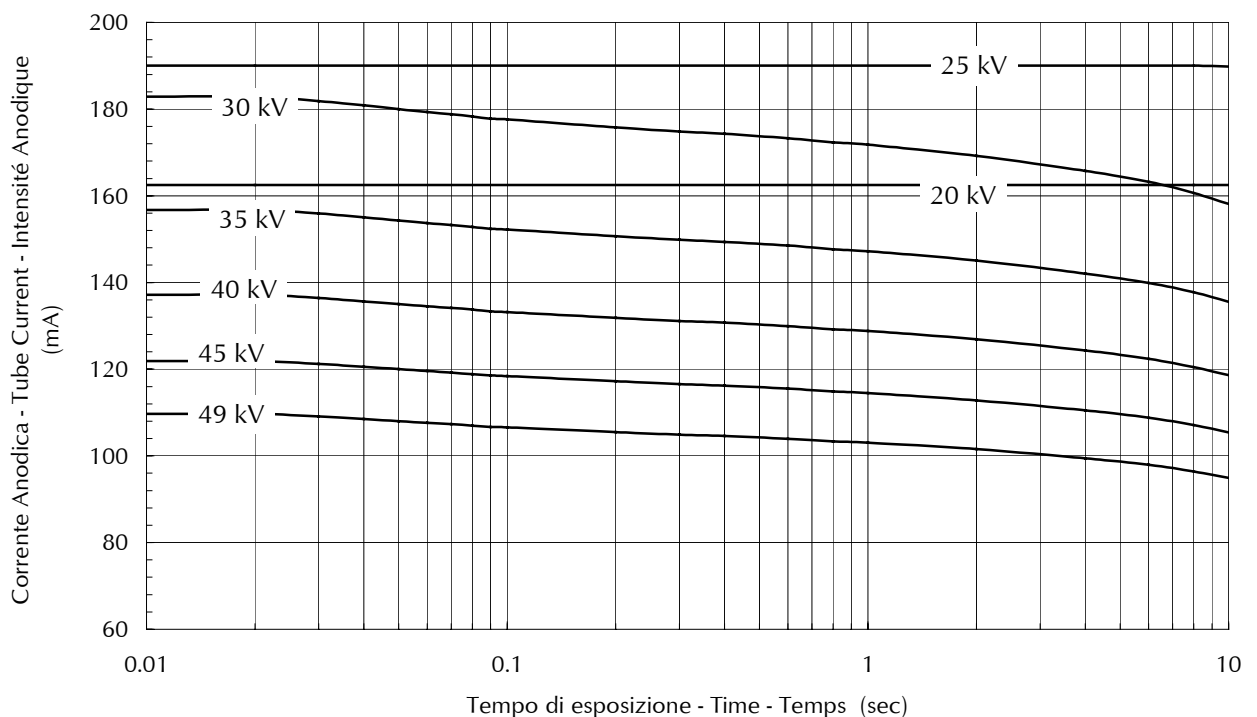



**CURVE DI CARICO SINGOLO - SINGLE LOAD RATING - ABAQUE DE CHARGE UNIQUE**

▣ 0.1 - 3 ~ - 10000 min<sup>-1</sup>

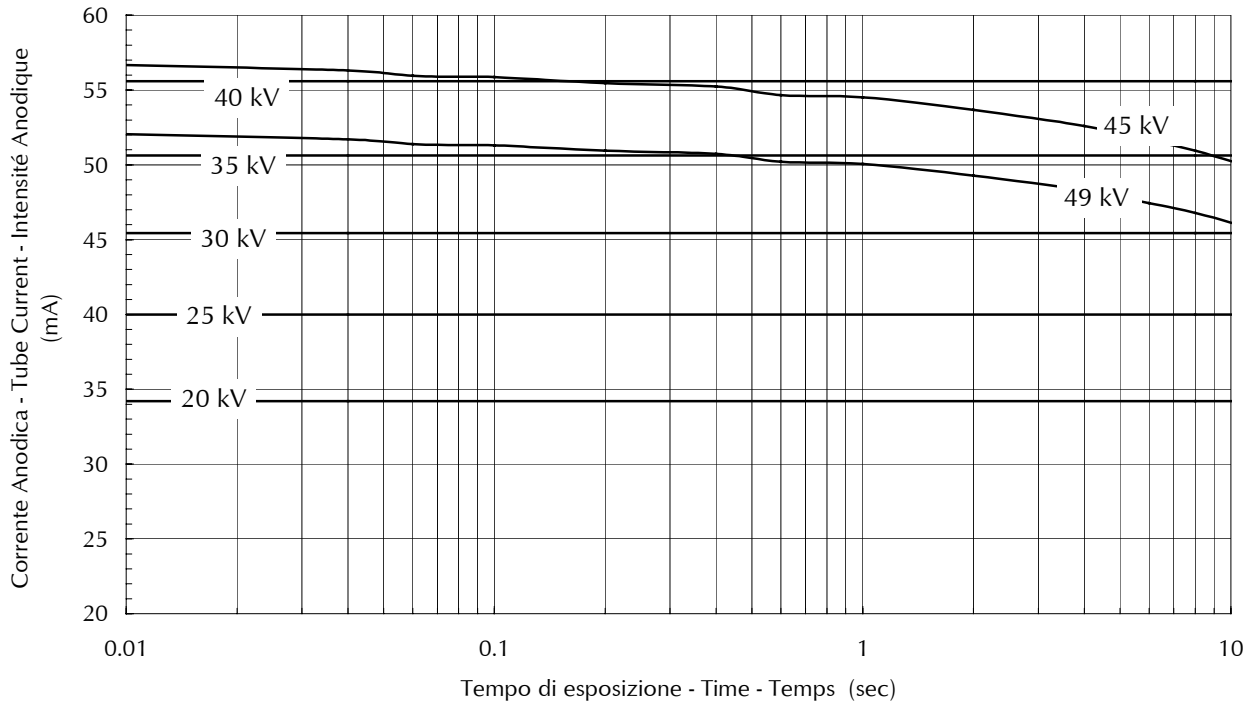

**CURVE DI CARICO SINGOLO - SINGLE LOAD RATING - ABAQUE DE CHARGE UNIQUE**

■ 0.3 - 3 ~ - 10000 min<sup>-1</sup>

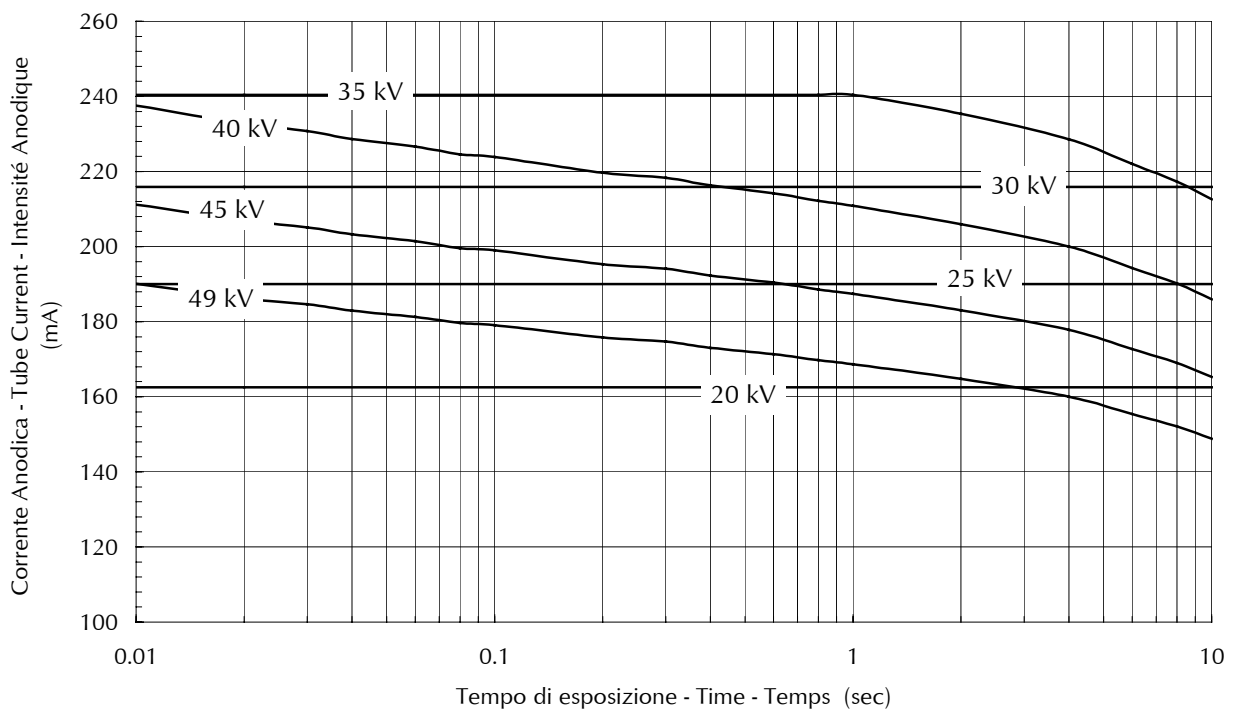

**Caratteristica di emissione del catodo**  
**Cathode emission characteristic**  
**Caractéristique d'émission de la cathode**

▣ 0.1 - 3 ~ - (± 0.2 A)

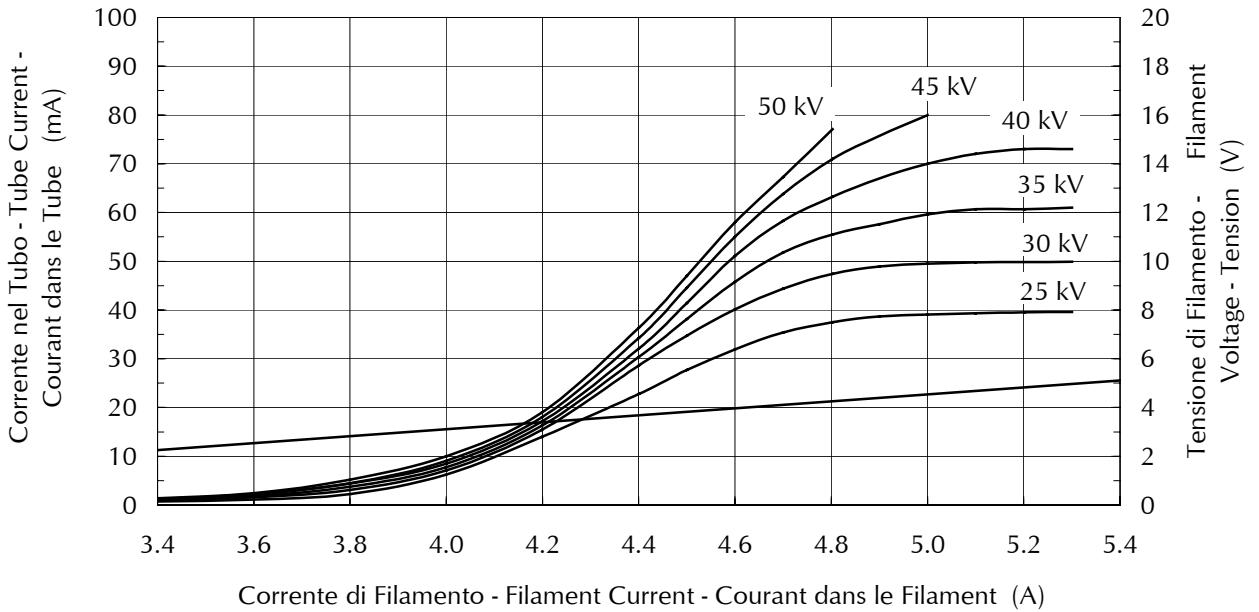

**Caratteristica di emissione del catodo**  
**Cathode emission characteristic**  
**Caractéristique d'émission de la cathode**

■ 0.3 - 3 ~ - (± 0.2 A)

